

# Or

**Catalogo prodotti**  
Products catalogue  
Produktkatalog

**GSI<sup>®</sup>**

ceramic  
elements  
italian  
made.

**Gran parte del progresso sta nella volontà di progredire.**  
Much of progress lies in the will to progress.  
Fortschritt besteht wesentlich darin, fortschreiten zu wollen.

Seneca

## **Italian Made**

I prodotti presenti in questo volume sono progettati e realizzati in Italia secondo i più alti standard qualitativi, nella tutela dell'ambiente, dei diritti e della salute dei lavoratori.

The products in this catalog are designed and produced in Italy according to the highest quality standards, the environmental protection and of course according to the rights and health of employees.

Die Produkte in diesem Katalog wurden in Italien unter Achtung der höchsten Qualitätsanforderungen, des Umweltschutzes und selbstverständlich der Rechte und der Gesundheit der Mitarbeiter entworfen und hergestellt.

<b>Introduzione</b> <b>Introduction</b> <b>Einleitung</b>	1	<b>Sand</b>	39	<b>Norm</b>	67	<b>Kube</b>	85
<b>Azienda</b> Company Unternehmen	4	<b>Introduzione</b> Introduction Einleitung	42	<b>Introduzione</b> Introduction Einleitung	70	<b>Introduzione</b> Introduction Einleitung	88
<b>Produzione</b> Manufacturing Herstellung	8	<b>Abaco</b> Products index Produktverzeichnis	40	<b>Abaco</b> Products index Produktverzeichnis	68	<b>Abaco</b> Products index Produktverzeichnis	86
<b>Qualità senza compromessi</b> Quality without compromises Qualität ohne Kompromisse	12	<b>Disegni tecnici</b> Technical drawings Technische Zeichnungen	173	<b>Disegni tecnici</b> Technical drawings Technische Zeichnungen	183	<b>Disegni tecnici</b> Technical drawings Technische Zeichnungen	193
<b>Swirlflush</b>	14						
<b>Extraglaze</b>	16						
<b>Save water</b>	18	<b>Pura</b>	109	<b>Modo</b>	133	<b>Classic</b>	145
<b>Quick release</b>	20						
<b>Softclose</b>	21						
<b>Dual White</b>	22						
<b>Nel mondo</b> In the world Weltweit	24	<b>Introduzione</b> Introduction Einleitung	112	<b>Introduzione</b> Introduction Einleitung	136	<b>Introduzione</b> Introduction Einleitung	148
<b>Mercati</b> Markets Märkte	25	<b>Abaco</b> Products index Produktverzeichnis	110	<b>Abaco</b> Products index Produktverzeichnis	134	<b>Abaco</b> Products index Produktverzeichnis	146
		<b>Disegni tecnici</b> Technical drawings Technische Zeichnungen	203	<b>Disegni tecnici</b> Technical drawings Technische Zeichnungen	215	<b>Disegni tecnici</b> Technical drawings Technische Zeichnungen	221
		<b>Community</b>	161				
		<b>Introduzione</b> Introduction Einleitung	164				
		<b>Abaco</b> Products index Produktverzeichnis	162				
		<b>Disegni tecnici</b> Technical drawings Technische Zeichnungen	229				



GSI ceramica è uno dei principali leader nel settore ceramico italiano e internazionale, azienda innovativa e punto di riferimento per il settore dell'arredobagno. La sua attività risale alle origini della tradizione produttiva del distretto ceramico di Civita Castellana, che ha saputo nel tempo far fronte alle sfide del mercato. In questo contesto i fondatori di GSI ceramica hanno modellato in maniera sapiente la tradizione artigianale insieme con la prorompente innovazione tecnologica in un processo di ricerca e rinnovamento continui, fondati su di un'etica del lavoro ed un sistema di valori che pone al centro dell'attenzione la dimensione umana, ed il saper fare tipico della produttività italiana. Così il rapporto fruttuoso tra imprenditore, progettista, operaio e management ha innescato un circolo virtuoso che consente di offrire prodotti dall'elevato standard qualitativo, secondo quello che è diventato il credo di GSI ceramica, "Italian Made". Soprattutto a partire dagli anni Novanta l'azienda riceve la spinta più forte verso l'innovazione, sotto la guida di un rinnovato management, giovane e preparato, che crede fortemente nel piano di sviluppo avviato, e che sta portando avanti una politica di crescita che vedrà ancora, nel prossimo futuro, GSI ceramica protagonista e interprete del buon Made in Italy.

GSI has always been one of the leader company in Civita Castellana's ceramics industry tradition. Since the 30's GSI has been using its entrepreneurial spirit to overcome market difficulties. In this context the founders of the company have cleverly modelled traditional craftsmanship with evolving technical innovations in a Research and Development process based on a work ethic and value system which focuses on the human insight and know-how typical of Italian industry. In this way there is a productive relationship between investors, management, designers and workers which has led to a virtuous circle enabling us to offer products with a clean designs and high standards of quality, following what has become GSI's byword, "Italian Made". The 90's are those characterized by a greater push towards innovation in a process of transformation that will bring the company to a total refurbishment obtained with considerable investment and aimed at increasing the human capital and technological-productivity. Aiming at obtaining tangible results in terms of innovation is the focus of GSI today thanks to a renewed management team that strongly believes in the new development plan. In a historic moment like today, where caution seems the only way forward, GSI ceramics continues its policy of growth building a bridge to an upcoming future that will see the company as a real protagonist and interpreter of good Made in Italy.

GSI gehört seit jeher zu den führenden Unternehmen in der traditionellen Keramikindustrie von Civita Castellana. Seit den 30er Jahren zeigt GSI Unternehmegerist und überwindet damit die Schwierigkeiten auf dem Keramikmarkt. In diesem Zusammenhang haben die Unternehmensgründer in kontinuierlicher Forschung und Entwicklung handwerkliche Traditionen mit technischen Innovationen miteinander verbunden. Sie stützen sich dabei auf eine Arbeitsethik und ein Wertesystem, dass die Bedürfnisse des Menschen und das Geschick der italienischen Industrie in den Mittelpunkt stellt. Auf diese Weise entsteht ein produktives Zusammenwirken der Investoren, der Unternehmensleitung, der Designer und der Mitarbeiter und unser gemeinsames Ergebnis sind Produkte mit klarem Design und hohen Qualitätsmaßstäben, die sich im Leitsatz "Italian Made", von GSI manifestieren. Insbesondere in den 90ern wurde ein deutlicher Veränderungsprozess in Richtung Innovation angestoßen, innerhalb dessen das Unternehmen durch beträchtliche Investitionen in sowohl Humanressourcen als auch in technologische Produktivität komplett neu gestaltet wurde. Heute liegt der Fokus von GSI darauf, greifbare Ergebnisse in Sachen Innovation zu erzielen, nicht zuletzt mithilfe des neuen Managementteams, das überzeugt hinter dem jüngsten Entwicklungsplan steht. Mit dieser Wachstumspolitik möchte GSI ceramica auch eine Brücke in die Zukunft schlagen und das Unternehmen als Protagonist und Darsteller des guten "Made in Italy" präsentieren.









---

Manualità e automazione, artigianalità e tecnologia. I prodotti GSI ceramica sono il risultato di un complesso processo di sviluppo che impiega elevati livelli di tecnologia in ogni sua fase, dalla progettazione computerizzata in 3D alla prototipazione, all'innovativo sistema produttivo in alta pressione, alla smaltatura automatizzata ed al sistema di cottura a 1250°C sempre sotto il severo controllo del personale qualificato addetto alle operazioni di test e verifica. Ogni fase produttiva, ogni singolo articolo vengono testati per rispondere ad un rigido sistema di controllo nel rispetto delle più recenti normative europee di settore. Requisiti tecnici, funzionali ed estetici configurano un sistema di selezione dei prodotti che consente a GSI ceramica di offrire alla sua clientela solo i prodotti qualitativamente migliori dotati di documenti di certificazione CE. Negli ultimi anni l'azienda ha arricchito la sua dotazione produttiva installando impianti di colaggio ad alta pressione, i più innovativi ed efficienti per il settore ceramico. Questa tecnologia, di ultima generazione, permette di monitorare e controllare ogni fase di lavorazione del ciclo produttivo innescando un processo che innalza notevolmente il livello qualitativo del prodotto finito.

Manual ability and automation, craftsmanship and technology. GSI products are the result of a complex development process which harnesses the latest 3D system technology in every phase of design and prototyping. This is followed by a high pressure production method, automated enamelling and setting in a kiln running at 1250°C. The entire process is supervised in detail by qualified staff who carry out constant quality checking. Each phase of production, and every item produced, is tested against a strict quality control system conforming to the latest European standards. Technical, functional and aesthetic requirements form a selected system of products which allow GSI ceramics to only offer its clientele products that are of high level quality endowed with the certified document CE. Over the last few years, the company has invested in the latest generation production plants; high pressure casting systems which are the most innovative and efficient in the sector. This latest technology, allows a quality improvement and also grants a strict supervision throughout the entire production phase, considerably raising the qualitative standards of the finished product.

Handwerkliches Können und Automatisierung, Kunstfertigkeit und Technologie. Die GSI-Produkte sind das Ergebnis eines vielschichtigen Entwicklungsverfahrens, das in jeder Phase des Entwurfs und der Entwicklung von Prototypen die neueste Technologie des 3D-Systems einsetzt. Es folgen ein Hochdruck-Herstellungsverfahren, eine automatisierte Glasur und das Brennen im Ofen bei 1250°. Der gesamte Prozess wird bis ins Detail von qualifizierten Mitarbeitern überwacht, die durchgängig Qualitätskontrollen durchführen. In jeder Herstellungsphase wird jeder produzierte Artikel entsprechend eines strengen Qualitätssicherungssystems unter Einhaltung der geltenden europäischen Richtlinien getestet. Die Auswahl der Produkte erfolgt nach technischen, funktionalen und ästhetischen Gesichtspunkten, so dass GSI seinen Kunden nur Produkte mit höchster Qualität bietet und mit einer Bescheinigung zur CE-Kennzeichnung versehen kann. Während der vergangenen Jahre hat das Unternehmen in die jüngste Generation von Herstellungsanlagen investiert, wie die Systeme des Hochdruckgusses, die derzeit die innovativsten und effizientesten auf dem Markt sind. Diese neueste Technologie führt zu einer weiteren Qualitätssteigerung durch die nun mögliche, genaue Überwachung während des gesamten Herstellungsprozesses, wodurch die Qualitätsmaßstäbe des Endprodukts deutlich erhöht werden.





**Qualità senza compromessi**  
Quality without compromises  
Qualität ohne Kompromisse

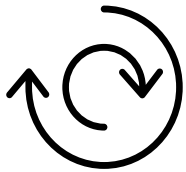
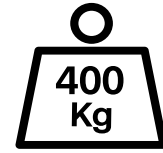

swirlflush®

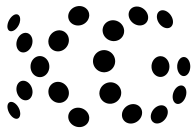
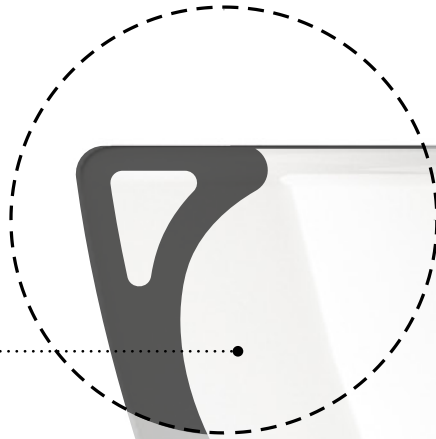

extraglaze®



<https://goo.gl/4vgkD1>

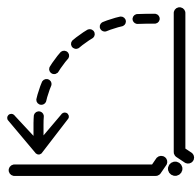

softclose

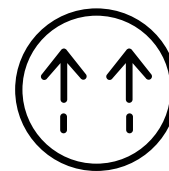

quickrelease



silent



save water

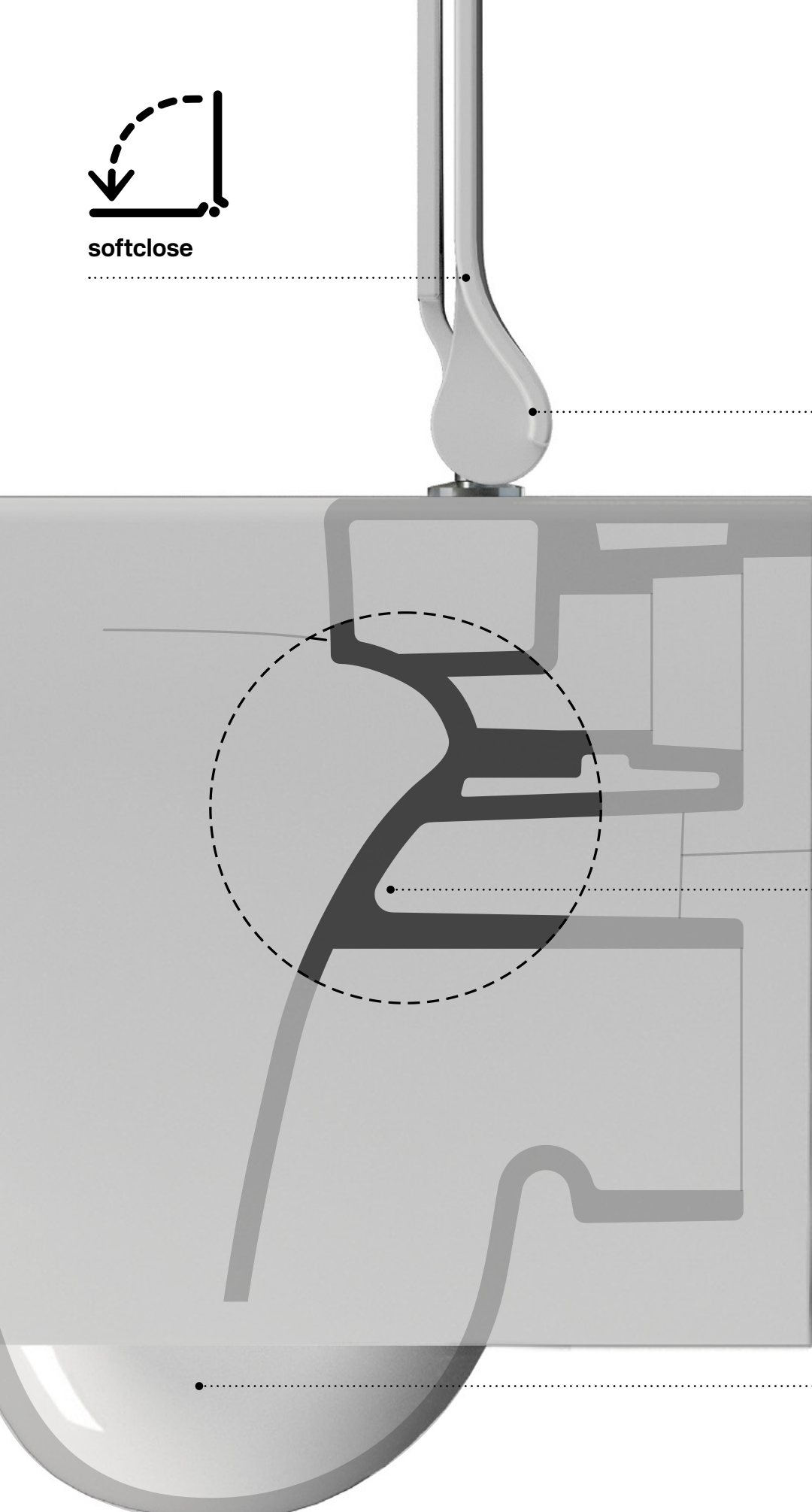

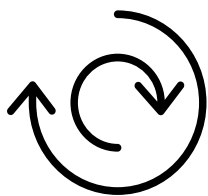

# swirlflush®

**Silenzioso, igienico, pulito.**  
**Silent, hygienic, clean.**  
**Still, hygienisch, sauber.**

La costante volontà di migliorare le qualità dell'ambiente bagno, ha portato i tecnici di GSI a studiare e sviluppare il rivoluzionario sistema di scarico Swirlflush®. La caratteristica più evidente è l'assenza della tradizionale bordatura, la brida, all'interno della quale, in un normale wc, circola l'acqua al momento dello scarico. La particolare conformazione del sistema Swirlflush® direziona l'acqua sulle superfici ceramiche in maniera uniforme, assicurando una pulizia ottimale, migliorando le performance di scarico e riducendo al minimo il rumore. Il design Swirlflush®, non presentando parti nascoste o difficili da raggiungere, facilita inoltre le normali operazioni di pulizia del sanitario. Questo, combinato al rivestimento ceramico Extraglaze®, che rende le superfici estremamente levigate e lisce, garantisce un'igiene ottimale con il minimo sforzo.

With a constant desire to enhance the quality of the bathroom, GSI engineers have studied and developed the revolutionary Swirlflush® flushing system. The most evident characteristic is the absence of the traditional edge, the rim, inside which, in a standard WC, water circulates when flushing. The special shape of the Swirlflush® system steers flush water evenly on ceramic surfaces, ensuring perfect cleansing and better draining, and minimising noise. The Swirlflush® design has no hidden or difficult to reach parts, and thus routine cleaning operations are made easier. This, combined with the Extraglaze® coating, makes surfaces extremely smooth, ensuring perfect hygiene with the minimum effort.

Das konstante Streben nach Verbesserung der Badezimmerqualität hat die Techniker von GSI dazu veranlasst, das revolutionäre Spülsystem Swirlflush® zu entwickeln. Dessen Hauptmerkmal besteht im Fehlen des traditionellen Spülrandes, durch den bei einem normalen WC das Wasser beim Spülen geleitet wird. Die besondere Gestaltung des Swirlflush® Systems richtet das Wasser gleichmäßig auf die Keramikoberflächen und sichert dadurch optimale Sauberkeit bei zugleich verbesserter Spüleistung und geringerer Geräuschentwicklung. Da das Design von Swirlflush® keine verborgenen oder schwer erreichbaren Teile beinhaltet, werden ferner die normalen Reinigungsvorgänge des WCs erleichtert. Dies garantiert in Kombination mit der Keramikbeschichtung Extraglaze®, die für extrem polierte und glatte Oberflächen sorgt, optimale Hygiene bei minimalem Einsatz.



Il nuovo sistema di risciacquo SwirlFlush®, con una rumorosità di soli 64db, garantisce estrema silenziosità durante la fase di scarico.

Swirlflush® new flushing system with a noise level of just 64dB, is extremely quiet during the flushing performance.

Das neue Spülsystem, hat einen Geräuschpegel von nur 64 dB und garantiert damit extrem leises Spülen.

— Standard WC  
— SwirlFlush®

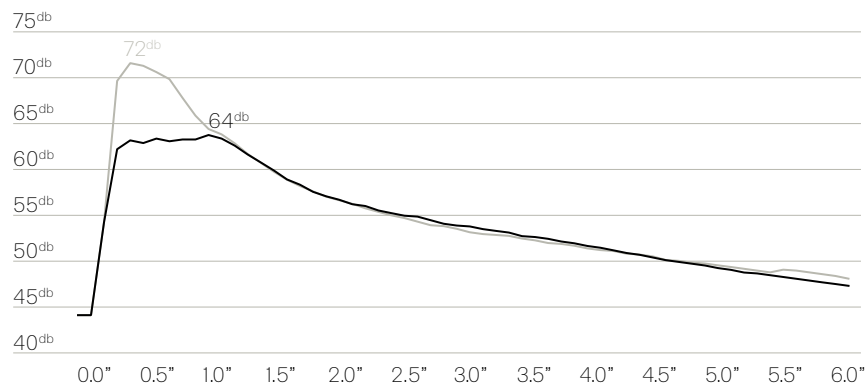



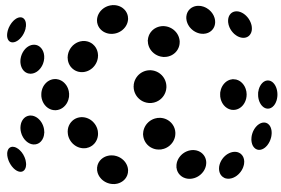

# extraglaze®

Extraglaze® è un nuovo smalto ceramico che, riducendo al minimo la formazione di pori superficiali, rende le superfici ceramiche più levigate, brillanti e facilmente lavabili. Extraglaze® viene applicato ai prodotti durante il ciclo di produzione e prima della loro cottura. In questo modo il nuovo smalto è parte integrante della ceramica ed i suoi effetti permanenti. I prodotti trattati con Extraglaze® sono più resistenti agli agenti chimici, e grazie all'estrema levigatezza e brillantezza, sono protetti da calcare e batteri e rimangono pulite più a lungo.

Extraglaze® is a new ceramic glaze which by minimizing the formation of surface pores, makes the ceramic surfaces smoother, brighter and easily washable.

Extraglaze® is applied to the products during the production cycle and prior to their firing. In this way, the new enamel is an integral part of the ceramic and its permanent effects.

The products treated with the ExtraGlaze® are more resistant to chemicals, and thanks to the extreme smoothness and brightness, they are protected from bacteria and limestone and stay clean longer.

Bei Extraglaze® handelt es sich um eine Keramikglasur, die die Bildung von Oberflächenporen reduziert und somit die Keramikoberflächen glatter, glänzender und pflegeleichter macht.

Extraglaze® wird auf die Produkte während der Herstellung und vor dem Brennen aufgetragen. Auf diese Weise ist die Glasur ein Bestandteil der Keramik und dauerhaft wirksam.

Die mit Extraglaze® behandelten Produkte sind resistenter gegen Chemikalien und dank der glatten und glänzenden Oberfläche sind sie besser vor Bakterien und Kalkstein geschützt und bleiben länger.

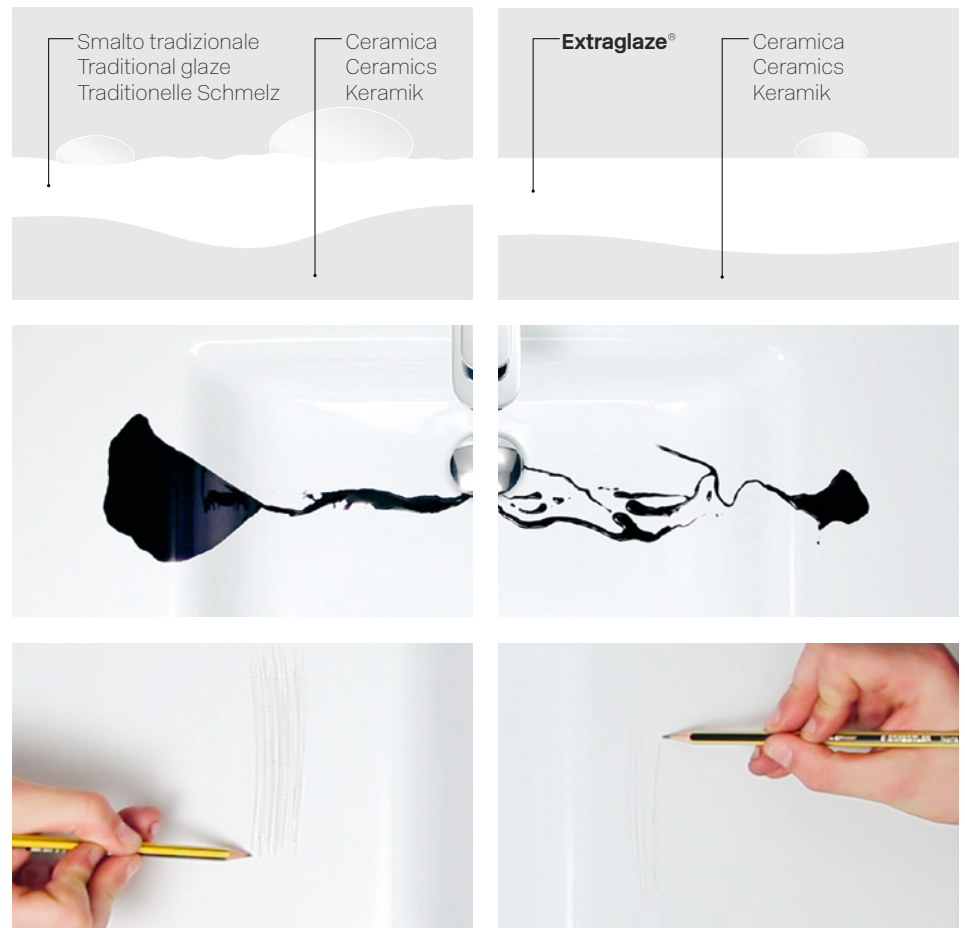



**Qualità:** superfici ceramiche tecnicamente avanzate, resistenti agli agenti chimici, levigate e brillanti, mantengono queste caratteristiche inalterate nel tempo.

**Quality:** technically advanced ceramic surfaces, chemical-resistant, smooth and shiny, which keep these characteristics unchanged in time.

**Qualität:** technisch fortschrittliche, chemikalienfeste, polierte und glänzende Keramikoberflächen, die diese Eigenschaften unverändert auf lange Zeit bewahren.



**Efficienza:** grazie all'estrema planarità delle superfici, l'acqua scivola molto più facilmente migliorando notevolmente le operazioni di risciacquo e scarico.

**Efficiency:** thanks to the extreme flatness of the surfaces, the water flows much easier, dramatically improving the rinsing and flushing operations.

**Effizienz:** dank der extremen Ebenheit der Oberflächen rinnt das Wasser sehr viel leichter ab, wodurch die Spül- und Abflussvorgänge erheblich verbessert werden.



**Igiene:** l'estrema planarità micrometrica delle superfici riduce enormemente l'accumulo di sporco e calcare, garantendo di conseguenza una pulizia e un'igiene ottimali.

**Hygiene:** the extreme micrometric flatness of the surfaces enormously reduces the accumulation of dirt and limestone, thereby ensuring an optimal cleaning and hygiene. **Hygiene:** die extreme mikrometrische Ebenheit der Oberflächen reduziert das Entstehen von Schmutz- und Kalkablagerungen stark, wodurch optimale Sauberkeit und Hygiene garantiert werden.



**Sostenibilità:** Extraglaze® consente un minor consumo di acqua e detersivi per le comuni operazioni di pulizia.

**Sustainability:** Extraglaze® allows a minor use of water and detergents during common cleaning. **Nachhaltigkeit:** Extraglaze® sorgt für verringerten Verbrauch an Wasser und Reinigungsmitteln für die gewöhnlichen Reinigungsvorgänge.



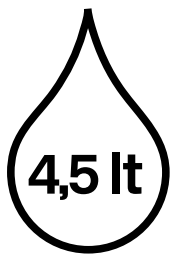

# save water

**L'acqua è un diritto, sprecarla è un delitto**  
**Water is a right, wasting it is a crime**  
**Wasser ist ein Recht,**  
**Wasserverschwendung ist eine Straftat.**

Con la volontà di preservare il bene più prezioso che ci appartiene, GSI progetta tutti i sanitari integrando lo speciale sistema di scarico "Save Water". Il sistema, creato dall'ufficio stile GSI ceramica, è frutto di un continuo lavoro di sviluppo e perfezionamento tecnico, ed è ottenuto grazie alla particolare conformazione delle parti ceramiche a contatto con l'acqua. Il sistema "Save Water" consente di eseguire le funzioni di scarico con soli 4,5 lt di acqua. Nel presente catalogo il logo "Save Water" individua i wc che sono dotati dell'efficiente sistema di scarico a 4,5 lt.

Aiming to preserve the most valuable asset that we have, GSI designs all its sanitary ware with the special flush system "Save Water". The system, created by the GSI design team, is the result of continuous technical development and is achieved thanks to the special shape of the ceramic parts directly in contact with water. The "Save Water" system allows you to flush with just 4,5 litres of water. In this catalogue the logo "Save Water" identifies toilets that have this system implemented.

Zum Schutz der wertvollsten Ressource des Menschen stattet GSI die gesamte Sanitärkeramik mit dem besonderen Spülsystem "Save Water" aus. Das vom GSI-Designerteam entworfene System ist das Ergebnis einer kontinuierlichen technischen Entwicklung und beruht auf der besonderen Form der Keramikteile, die in direktem Kontakt mit dem Wasser sind. Dank des "Save Water"-Systems werden beim Spülen nur 4,5 Liter verbraucht. In diesem Katalog sind die Toiletten mit diesem System mit dem Logo "Save Water" gekennzeichnet.

**9**  
**i litri di acqua**  
**generalmente utilizzati**  
liters of water generally used  
allgemein verbrauchte  
Liter Wasser



**6**  
**i litri di acqua richiesti**  
**dalle normative europee**  
liters of water required  
by European standards  
von den europäischen Richtlinien  
vorgeschriebene Liter Wasser



**4,5**  
**i litri di acqua utilizzati**  
**da un wc GSI**  
liters of water used  
by a GSI wc  
von einem GSI-WC  
verbrauchte Liter Wasser





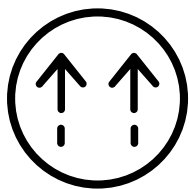

# quickrelease



GSI ceramica introduce un nuovo copriwater con un innovativo sistema di installazione. Il nuovo sistema "Quick Release" si contraddistingue per la facilità con cui permette di estrarre il copriwater in maniera semplice e senza l'impiego di utensili di alcun genere. È sufficiente tirare il copriwater verso l'alto esercitando una forza sufficiente alla sua estrazione. In questo modo sarà possibile eseguire le operazioni di pulizia del copriwater e del wc anche nelle superfici generalmente difficili da raggiungere garantendo una maggiore igiene. Altrettanto semplice sarà il riposizionamento del copriwater: una volta posizionato in corrispondenza delle cerniere sarà sufficiente esercitare una pressione relativamente debole. In abbinamento al sistema di chiusura soft-close i copriwater GSI raggiungono livelli di efficienza e comfort senza precedenti. Il sistema soft-close predispone il copriwater per una chiusura rallentata. Questo consentirà di evitare cadute accidentali e chiusure del copriwater troppo violente garantendo comfort ed evitando danni accidentali.

GSI ceramica introduces a new seat & cover with an innovative installation system. The new "Quick Release" system is distinguished by the simplicity with which it allows to pull out the seat & cover in a simple way and without the use of any kind of tool. Simply pull the seat and cover up using a sufficient force for its removal. This will make it possible to clean the toilet seat and even the wc in areas that are usually difficult to reach, granting a major hygiene. Repositioning the seat & cover is as simple; once placed on the hinges, it will be will be sufficient to employ a relatively weak pressure. Matching up with the soft-close system, the GSI seat and covers reach levels of efficiency and comfort never reached before. The soft-close system predisposes the seat and cover for a slow closing. This will prevent accidental falls and violent closures of the seat and cover, preventing damages.

GSI ceramica führt einen neuen WC-Sitz mit einem innovativen Installationssystem ein. Das neue „Quick Release“ System unterscheidet sich von anderen durch die Einfachheit, mit der der WC-Sitz ohne den Einsatz von Werkzeugen abgenommen werden kann. Einfach den WC-Sitz mit ausreichend Kraft zum Hochheben entfernen. So kann der WC-Sitz und das WC auch an Stellen gereinigt werden, die normalerweise schwierig zu erreichen sind, und die Hygiene ist verbessert. Das Zurücksetzen des WC-Sitzes ist genauso leicht: einfach auf die Scharniere platzieren und mit leichtem Druck einsetzen. In Verbindung mit dem Soft Close-Mechanismus ist der WC-Sitz so funktionsfähig und bequem wie nie zuvor. Der Soft Close-Mechanismus sorgt dafür, dass der WC-Sitz langsam schließt. Dadurch wird verhindert, dass der Sitz versehentlich oder zu heftig auf die Brille fällt und diese beschädigt werden.



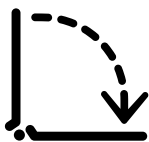

# dual white



Con Dual White, GSI coniuga igiene ed eleganza conferendo un tratto originale e distintivo ai propri sanitari. La tecnologia Dual White, che combina la smaltatura opaca alla lucida, è la novità indirizzata ad una clientela attenta ai particolari e alle innovazioni sul mercato. La purezza della finitura opaca incontra, nelle parti idrauliche a contatto con l'acqua, la smaltatura Extraglaze®, evitando macchie ed antigienici residui calcarei, frequenti conseguenze della tipica porosità del prodotto in ceramica con un'unica finitura opaca. Al contrario, la levigatezza delle superfici ceramiche smaltate con Extraglaze® diminuisce l'attrito che l'acqua incontra durante la fase di scarico del wc, migliorandone le performance e riducendo sensibilmente il consumo di acqua. Oltre a ciò, il connubio Extraglaze®/Swirlflush® arricchisce ulteriormente la dotazione del wc: efficienza dello scarico, silenziosità, maggior igiene e pulizia derivante dall'assenza della brida. Setosa, materica, sofisticata e di tendenza, la finitura Dual White esalta alla perfezione le morbide linee della collezione Pura.

GSI has combined hygiene and elegance in its Dual White range, giving sanitaryware an original and distinctive touch. Dual White technology combines gloss and matt glazes in a range of products aimed at customers with an eye for detail and for innovation.

Where parts come into contact with water, the purity of the matt finish meets our Extraglaze® enamel, designed to prevent unhygienic lime deposits, a frequent phenomenon due to the porous nature of ceramic products having a single matt finish. The smoothness of ceramic surfaces coated with Extraglaze® enamel reduces the friction encountered by water when the WC is flushed, enhancing its performance and significantly reducing water consumption. The Extraglaze®/Swirlflush® double act further enhances the WC: efficient, quiet flushing, greater hygiene and cleanliness due to the rimless bowl. Silky, tactile, sophisticated and stylish, the Dual White finish is a perfect ally for the soft lines of the Pura collection.

Bei Dual White kombiniert GSI Hygiene mit Eleganz und verleiht dadurch den Sanitärobjekten einen unterscheidenden Zug. Die Dual-White-Technologie, bei der Matt- und Glanzglasur miteinander verbunden werden, stellt die Neuheit dar, die sich an Kunden mit einem besonderen Augenmerk für innovative Details wendet.

Die Reinheit der matten Oberflächen trifft bei den im Kontakt mit Wasser stehenden Teilen auf die Glasur Extraglaze®, dank der Fleckenbildung und unhygienische Kalkablagerungen verhindert werden, die oftmals Folge jener typischen Porosität von Keramikprodukten mit einheitlich matt glasierter Oberfläche sind. Im Gegensatz dazu verringert die Glätte der mit Extraglaze® glasierten Keramikflächen die Reibung, auf die das Wasser in der Spülphase des WCs stößt, wodurch die Leistung verbessert und der Wasserverbrauch reduziert wird. Zusätzlich bereichert die Kombination Extraglaze®/Swirlflush® die Ausstattung des WCs weiter: effiziente und zugleich leise Spülung, verbesserte Hygiene und Sauberkeit dank des fehlenden Spülrands. Seidig, stofflich, raffiniert und tendenzweisend: Dual White hebt die Perfektion und die sanften Linien der Kollektion Pura hervor.





# Nel mondo In the world Weltweit

Situata nel cuore del principale distretto ceramico in Italia per la produzione di sanitari, GSI trae dalla tradizione tutta la sua vitalità, il suo carattere dinamico ed il suo spirito intraprendente. Innovazione, design ed apertura verso l'esterno hanno consentito a GSI, nel corso del tempo, di intessere una rete di relazioni internazionali con clienti, partner commerciali, ed estimatori in senso più ampio che permette all'azienda di essere partecipe ed interprete del Made in Italy anche fuori dal mercato domestico con la partecipazione ad eventi, convegni e progetti per il contract come testimoniano il Tiara Chateau Hotel di Parigi, il Madinat Jumeirah di Dubai, il Vip Grand di Lisbona, il Yas Marina di Abu Dhabi e molti altri.

Located in the heart of Italy's primary ceramic sanitary ware production district, GSI draws its vitality, dynamism and enterprising spirit from this tradition. Innovation, design and being open to new trends has allowed GSI, over time, to weave a network of international relationships with clients, commercial partners and fans that allows the company to be a leading exponent of the Made in Italy brand outside the domestic market thanks to its presence at events, conferences and various projects such as the Tiara Chateau Hotel in Paris, Madinat Jumeirah in Dubai, Vip Grand Lisbon, Yas Marina in Abu Dhabi and many more.

GSI hat seinen Sitz im Herzen von Italiens größter Industriezone für Sanitärkeramik und zieht aus dieser Tradition seine Vitalität, seine Dynamik und seinen Unternehmergeist. Mit Innovation, Design und Aufgeschlossenheit gegenüber neuen Trends hat GSI im Laufe der Zeit ein Netzwerk internationaler Geschäftsbeziehungen mit Kunden, Handelspartnern und Bewunderern geschaffen und sich außerhalb des italienischen Markts dank der Teilnahme an Events, Konferenzen und verschiedener Projekte, wie dem Tiara Chateau Hotel in Paris, dem Madinat Jumeirah in Dubai, dem Vip Grand Lisboa Hotel und Yas Marina in Abu Dhabi, als führender Vertreter der Marke "Made in Italy" einen Namen gemacht.



Oltre che nel mercato domestico italiano, dove viene destinato il 53% del materiale prodotto, GSI ceramica è presente nei mercati internazionali dove colloca il 47% della sua produzione, in particolare nei paesi Europei, nei paesi emergenti dell'Est, nell'area Asiatica ed Araba fino alla Nuova Zelanda. Sostenuta dalla spinta della domanda di prodotti di qualità superiore, GSI ceramica prosegue nella sua politica di espansione nella fascia più evoluta dei diversi mercati.

Other than the national Italian market, where 53% of the produced material is destined, GSI is also present in the international markets where it sets 47% of its production, in particular in the European countries, the emerging countries of the East, in the Asiatic and Arab countries up-to New Zealand. Supported by the push of demand of products with high quality, GSI continues in its policy of expanding in the most evolved range of different markets.

Neben dem nationalen italienischen Markt, für den 53% der Produkte bestimmt sind, ist GSI auch mit 47% seiner Produktion auf den internationalen Märkten vertreten, darunter insbesondere die europäischen Länder, die aufstrebenden Länder im Osten, die asiatischen und arabischen Länder bis hin zu Neuseeland. Geflügelt von der starken Nachfrage nach hoch qualitativen Produkten setzt GSI seinen Wachstumstrend in den hoch entwickelten Bereichen verschiedener Märkte fort.

America: Bogotá, Philadelphia.

Asia: Abu Dhabi, Baku, Chennai, Delhi, Doha, Dubai, Hong Kong, Riyadh, Shanghai, Singapore, Tokyo.

Oceania: Auckland, Melbourne, Perth, Sydney.

Europe: Amsterdam, Athens, Belgrade, Bern, Cologne, Copenhagen, Düsseldorf, Frankfurt, Glasgow, Graz, Kiev, Larnaca, Lisbon, Ljubljana, London, Moscow, Munich, Nuremberg, Oslo, Porto, Prague, Riga, Rotterdam, Saint Petersburg, Salzburg, Sofia, Tirana, Valletta, Vilnius, Warsaw, Wien, Zagreb.



# Lavabi

## Washbasins

## Waschbecken

### Sand

**125**

9052111  
125x50



**70**

9087111  
70x40



**60/TS**

908311  
60x38



**120**

9024111  
120x50

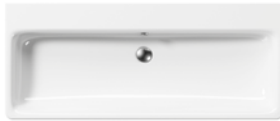

**55**

9086111  
55x40



**50/TS**

908211  
50x38



**100**

9023111  
100x50

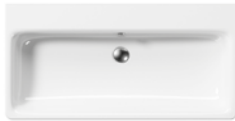

**40**

9084111  
40x32



**48/TS**

903511  
Ø48



**100**

9051111  
100x50



**42/TS**

904811  
Ø42



**80**

9022111  
80x50



**h85**

905811  
905911  
55x38



**70/TO**

904111  
70x42



**60**

9031111  
60x50



**60/TO**

904911  
60x42



**50**

9085111  
50x50



**42/TO**

902811  
Ø42



## Norm

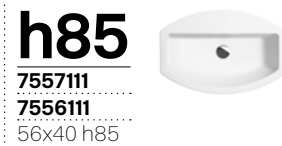
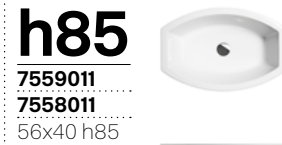

# Lavabi

## Washbasins

## Waschbecken

### Kube

**150**

8963111

150x50



**120**

8952111

120x47



**50**

8986011

50x25



**120**

8924111

120x47

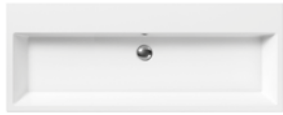

**100**

8951111

100x47



**40**

8984011

40x23



**100**

8923111

100x47

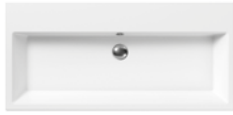

**80/d**

8956111

80x47



**80**

8922111

80x47



**80/s**

8957111

80x47



**60**

8931111

60x47



**60/d**

8938111

60x47



**50**

8930111

50x47



**60/s**

8939111

60x47

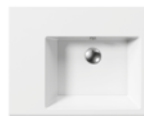

**45**

8985111

45x35



## Pura

**60/TS**

8983011

60x38



**120**

8824111

120x50



**102**

8825111

102x52



**50/TS**

8982011

50x38



**100**

8823111

100x50



**82**

8826111

82x52



**50/TI**

894711

50x37



**80**

8822111

80x50



**37/TI**

895011

37x37



**80/d**

8856111

80x50



**60/TI**

883711

60x38



**55/s**

8934111

55x47



**60**

8831111

60x50



**39/TI**

884611

Ø39



**58/i**

8933011

58x45



**38/TI**

885011

38x38



## Modo

## Classic

**60/TS**

888311

60x38



**120**

7724111

120x50



**125**

8725111

125x54



**50/TS**

888211

50x38



**100**

7723111

100x50



**105**

8723111

105x54



**48/TS**

883511

Ø48



**80**

7722111

80x50



**90**

8788111

90x50



**42/TS**

882811

Ø42



**65**

7732111

65x50



**75**

8787111

75x50



**50**

7785111

50x40



**60**

8731111

60x46



**55/U**

724311

55x38



**50/U**

724711

50x35



## Community

## Incasso

**60/T**

874911

60x40



**70**

7631011

70x60



**61/I**

MASIAN111

61x52



**57/I**

MALISEON111

57x47



**55/U**

724311

55x38



**50/U**

724711

50x35



**57/U**

MVULCN11

57x42





# Wc e Bidet

## Wc and Bidet

### Wc und Bidet

#### Sand

### 55

901211  
9065111  
54,5x37



### 55/F

901511  
54,5x37



### 50

901811  
9064111  
50x37



### 50/F

901611  
51x37



### 55

901411  
9062111  
54,5x37



#### Norm

### 55

861211  
8665111  
55x36



### 55/F

861511  
55x36



### 50

861811  
8664111  
50x36



### 50/F

861611  
50x36



### 45

861011  
45x35



### 55

861411  
8662111  
55x36



### 68

861711  
68x36



#### Kube

### 55

891211  
8965111  
55x36



### 55/F

891511  
55x36



### 50

891811  
8964111  
50x36



### 50/F

891611  
50x36



## Pura

### 55

881211  
8865111  
55x36



### 55/F

881511  
55x36



### 55/F

881111  
8861111  
54,5x35



### 50

881811  
8864111  
50x36



### 50/F

881611  
50x36



### 55

881411  
8862111  
55x36



### 55/F

881011  
55x36



### 50

881911  
8869111  
50x36



### 68

881711  
68x38



## Modo

### 55

771211  
7765111  
55x38



### 51

771011  
7760111  
51x38



## Classic

### 55

871211  
8765111  
55x37



### 54

871011  
871111  
8762111  
54x37



### 70

871711  
70x37



## Community

### 70

761811  
70x37



# Orinatoio

## Urinal

## Urinal

### Pura

**39**  
769711  
39x31



**36**  
889711  
36x25



### Community

**39**  
769711  
39x31



# Vasca

## Bathtub

## Badewanne

### Sand

**185**  
**VASAND90**  
 185x90



**180**  
**VASAND80**  
 180x80



### Kube

**179**  
**VAT80**  
 179x80



### Pura

**190**  
**VAPR90**  
 190x90



### Modo

**190**  
**VAM95**  
 190x95



### Classic

**175**  
**VAL1**  
**VAL2**  
 175x82



# Piatti doccia

## Shower trays

## Duschwannen

### H6

**140**

**358711**

140x80



**90/q**

**339711**

90x90



**120**

**359811**

120x80



**80/q**

**338611**

80x80



**120**

**359911**

120x70



**90**

**349711**

90x90



**100**

**358611**

100x80



**80**

**348611**

80x80



**100**

**358911**

100x70



**90**

**359711**

90x72



## H11

**120**

**299411**

120x80



**120**

**299311**

120x70



**100**

**298811**

100x80



**100**

**299111**

100x72



**90**

**259011**

90x72



**85**

**458511**

85x70



**90/q**

**439011**

90x90



**80/q**

**438011**

80x80



**75/q**

**437511**

75x75



**70/q**

**437011**

70x70



**90**

**449011**

90x90



**80**

**448011**

80x80



**90/d**

**459611**

90x70 dx



**90/s**

**459511**

90x70 sx





Sand



# Lavabi

## Washbasins

## Waschbecken

Sand

**125**

9052111

125x50

**70**

9087111

70x40

**60/TS**

908311

60x38

**120**

9024111

120x50

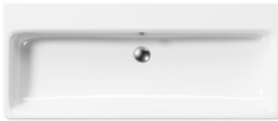
**55**

9086111

55x40

**50/TS**

908211

50x38

**100**

9023111

100x50

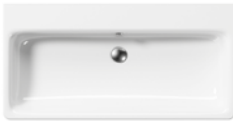
**40**

9084111

40x32

**48/TS**

903511

Ø48

**100**

9051111

100x50

**42/TS**

904811

Ø42

**80**

9022111

80x50

**h85**

905811

905911

55x38

**70/TO**

904111

70x42

**60**

9031111

60x50

**60/TO**

904911

60x42

**50**

9085111

50x50

**42/TO**

902811

Ø42



# Wc e Bidet

## Wc and Bidet

### Wc und Bidet

# Vasca

## Bathtub

### Badewanne

**70/TE**

908911

70x37



**55/TE**

903011

55x35



**45/TE**

903411

Ø45



**35/TE**

905011

Ø35



**60/I**

9033111

60x45



**55**

901211

9065111

54,5x37



**55/F**

901511

54,5x37



**50**

901811

9064111

50x37



**50/F**

901611

51x37



**55**

901411

9062111

54,5x37



**185**

VASAND90

185x90



**180**

VASAND80

180x80



Sand

## Sand

Sand è una collezione di sanitari dal carattere distintivo. Il suo design è fondato sull'idea progettuale di creare prodotti affascinanti. Già nel nome si intuisce l'intento creativo che si materializza in prodotti dalle forme sinuose e morbide ad evocare quelle delle immense distese sabbiose che per contrasto richiamano alla mente il flusso dell'acqua che scorre nei catini avvolgenti dei lavabi e dei sanitari Sand.

Sand is a sanitary ware range characterized by unique features. Its design is based on the idea of creating attractive products. From its name it is easy to picture the inspiration that was transformed into the sinuous and soft shapes of the range: deserted sandy beaches and the flow of water in the enveloping shape of Sand basins and sanitary ware.

Sand ist eine Sanitärkeramik-Serie mit einzigartigen Merkmalen. Das Design beruht auf der Idee, attraktive Produkte zu schaffen. Schon vom Namen ist ganz einfach die Inspirationsquelle abzuleiten, die sich in den geschmeidigen und weichen Formen des Sortiments widerspiegelt: leere Sandstrände und der Wasserfluss eingebettet in den Formen der Sand Becken und Badkeramik.





**Sand 125x50**  
Lavabo / Washbasin

**Sand 55x37**  
Wc-Bidet

**H6 140x80**  
Platto doccia / Shower tray





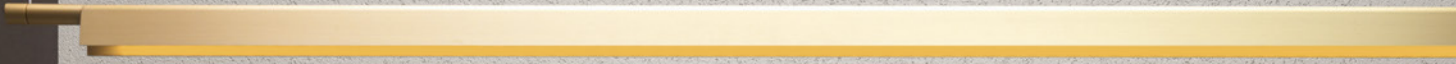





**Sand 55x35**  
Lavabo / Washbasin





Sand 045  
Lavabo / Washbasin





**Sand 100x50**  
Lavabo / Washbasin

**Sand 55x37**  
Wc-Bidet

**Sand 185x90**  
Vasca/Bath tub

**H6 120x80**  
Platto doccia / Shower tray



















**Sand Freestanding 55x38 h85**  
Lavabo / Washbasin

**Sand 55x37**  
Wc-Bidet

**Sand 180x80**  
Vasca/Bath tub





**Sand 50x38**  
Lavabo / Washbasin













**Norm**

# Lavabi

## Washbasins

## Waschbecken

Norm

**h85**

7559011

7558011

56x40 h85

**h85**

7557111

7556111

56x40 h85

**125**

8625111

125x50

**120**

8624111

120x50

**100**

8623111

100x50

**90**

8688111

90x50

**75**

8687111

75x50

**60**

8683111

60x50

**42**

8684111

42x34

**35**

8650111

35x26



# Wc e Bidet

## Wc and Bidet

### Wc und Bidet

**55****861211****8665111**

55x36

**55****861411****8662111**

55x36

**55/F****861511**

55x36

**50****861811****8664111**

50x36

**68****861711**

68x36

**50/F****861611**

50x36

**45****861011**

45x35



## Norm

Norm è la proposta minimalista di GSI ceramica, una collezione destinata ad un pubblico dal gusto evoluto che apprezza la purezza delle forme, le linee semplici e regolari prive di orpelli o segni inutili. I rapporti dimensionali, le caratteristiche di funzionalità e la declinazione nelle varie misure suggeriscono l'idea di una famiglia di sanitari capace di soddisfare innumerevoli esigenze di spazio e di personalizzazione. Inoltre, la predisposizione per l'abbinamento con accessori e arredi, rende possibile la creazione di un ambiente bagno piacevole, elegante, funzionale, minimalista.

Norm is GSI's minimalist offering, for the client with taste who appreciates simplicity. It is a simple range with nothing superfluous, nothing ornamental. Its multiple dimensions and functionality comprise a sanitary range which can be customised to meet a wide range of spaces and requirements. Once combined with accessories and fixtures, this range creates a pleasing, functional elegant and minimal bathroom space.

GSI hat Norm für Minimalisten entworfen, für Kunden mit Geschmack, die die Einfachheit schätzen. Es ist eine schlichte Serie ohne Überflüssiges und ohne Schnörkel. Diese Sanitärkeramik ist in zahlreichen Maßen und Funktionen erhältlich und kann so auf den einzelnen Kunden und sein Platzangebot und seine individuellen Anforderungen zugeschnitten werden. Kombiniert mit Zubehör und Inventar schafft diese Serie eine angenehme, funktionale, elegante und schlichte Badezimmerumgebung.









**Norm 125x50**  
Lavabo / Washbasin

**Norm 55x36**  
Wc-Bidet

**H6 140x80**  
Piatto doccia / Shower tray





**Norm 55x36**  
Wc-Bidet





ARQUITECTURA  
CON LA GENTE.  
PARA LA GENTE.



Norm Element Free 56X40 85  
Lavabo / Washbasin



Norm 55X36  
Wc-Bidet

**Norm 55x36**  
Wc Swirlflush





Norm 55x36  
Wc Swirflush





**Norm 120x50**  
Lavabo / Washbasin

**Norm 68x36**  
Monoblocco / Close Coupled

**Norm 55x36**  
Bidet





Norm 120x50  
Lavabo / Washbasin







# Lavabi

## Washbasins

## Waschbecken

Kube

**150****8963111**

150x50

p.75

**120****8952111**

120x47

p.75

**50****8986011**

50x25

p.85

**120****8924111**

120x47

p.75

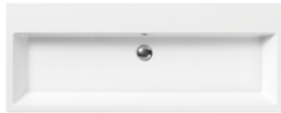
**100****8951111**

100x47

p.77

**40****8984011**

40x23

p.85

**100****8923111**

100x47

p.77

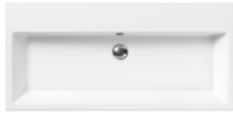
**80/d****8956111**

80x47

p.79

**80****8922111**

80x47

p.79

**80/s****8957111**

80x47

p.79

**60****8931111**

60x47

p.81

**60/d****8938111**

60x47

p.81

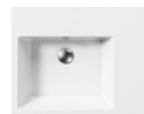
**50****8930111**

50x47

p.83

**60/s****8939111**

60x47

p.81

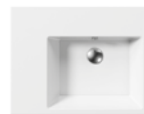
**45****8985111**

45x35

p.83



# Wc e Bidet

## Wc and Bidet

### Wc und Bidet

# Vasca

## Bathtub

### Badewanne

## 60/TS

8983011

60x38

p.87



## 50/TS

8982011

50x38

p.87



## 50/TI

894711

50x37

p.89



## 37/TI

895011

37x37

p.89



## 55/s

8934111

55x47

p.91



## 58/i

8933011

58x45

p.91



## 55

891211

8965111

55x36

p.93



## 55/F

891511

55x36

p.93



## 50

891811

8964111

50x36

p.95



## 50/F

891611

50x36

p.95



## 179

VAT80

179x80

p.97





## Kube

In linea con la rinnovata tendenza stilistica di GSI ceramica, Kube afferma con decisione il nuovo profilo progettuale dell'azienda. L'unicità formale della collezione esprime una solidità propria degli oggetti dal carattere forte. Con Kube GSI ceramica propone lavabi installabili ad appoggio, incasso, semincasso o sospensione.

In line with the renewed stylistic trend of GSI Ceramics, Kube strongly asserts the company's new profile. The uniqueness of the collection expresses a real solidity typical of products with strong character. With Kube GSI proposes ceramic washbasins available counter top built-in semi-recessed and wall-hung fitting.

Im Einklang mit den jüngsten Trends bei GSI Ceramica steht der Stil von Kube für das neue Profil des Unternehmens. Die Einzigartigkeit der Kollektion drückt sich in der Robustheit aus, die für Produkte mit starkem Charakter typisch ist. In der Serie Kube präsentiert GSI Waschbecken, die sowohl als Aufsatz-, Einbau-, Halbeinbau- und Wandwaschbecken erhältlich sind.





**Kube 100x47**  
Lavabo / Washbasin

**Kube 55x36**  
Wc-Bidet







**Kube 179x80**  
Vasca/Bathtub







**Kube 80x47**  
Lavabo / Washbasin

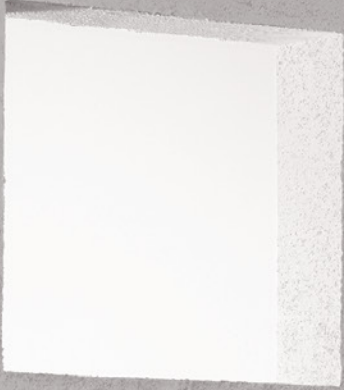

**Kube 55x36**  
Wc-Bidet





**Kube 50x38**  
Lavabo / Washbasin



**Kube 100x47**  
Lavabo / Washbasin



**Kube 58x45**  
Lavabo / Washbasin









**Kube 150x50**  
Lavabo / Washbasin

**Kube 55x36**  
Wc-Bidet



Kube 150x50  
Lavabo / Washbasin

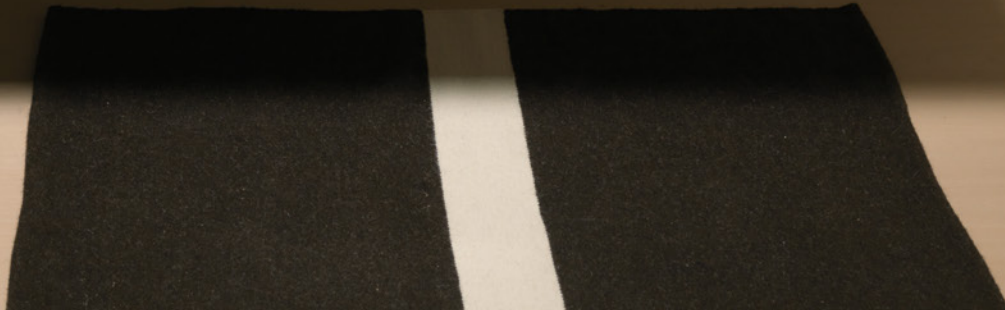





**Kube 40x23**  
Lavabo / Washbasin





Pura

# Lavabi

## Washbasins

## Waschbecken

Pura

**120**

8824111

120x50

**102**

8825111

102x52

**60/TS**

888311

60x38

**100**

8823111

100x50

**82**

8826111

82x52

**50/TS**

888211

50x38

**80**

8822111

80x50

**48/TS**

883511

Ø48

**80/d**

8856111

80x50

**60/TI**

883711

60x38

**42/TS**

882811

Ø42

**80/s**

8857111

80x50

**50/TI**

884711

50x38

**60**

8831111

60x50

**39/TI**

884611

Ø39

**55/U**

724311

55x38

**38/TI**

885011

38x38

**50/U**

724711

50x35



# Wc e Bidet

## Wc and Bidet

### Wc und Bidet

# Orinatoio

## Urinal

### Urinal

**55**

881211

8865111

55x36

**55**

881411

8862111

55x36

**39**

769711

39x31

**55/F**

881511

55x36

**55/F**

881011

55x36

**36**

889711

36x25

**55/F**

881111

8861111

54,5x35

**50**

881911

8869111

50x36

**50**

881811

8864111

50x36

**68**

881711

68x38



# Vasca

## Bathtub

### Badewanne

**50/F**

881611

50x36

**190**

VAPR90

190x90





## Pura

La collezione Pura si distingue per la razionalità progettuale e l'eleganza delle scelte stilistiche. Forme sobrie, che sapientemente bilanciano linee rette e morbidi arrotondamenti, frutto di un lungo lavoro di messa a punto a livello di design. La purezza minimalista delle linee fornisce ai prodotti appartenenti alla collezione di sanitari un'eleganza contemporanea ed una connotazione di lusso e raffinatezza secondo i valori di semplicità e accuratezza che contraddistinguono lo stile GSI.

The Pura collection is characterized by rational design and stylish elegance. Conservative shapes that skillfully balance straight lines and soft rounding are the result of a long design and development process. The understated purity of the lines gives the products in this range a contemporary elegance and a touch of luxury and refinement that fits with the simple but tasteful style of GSI.

Die Pura Kollektion ist durch ihr schlichtes Design und ihre stilvolle Eleganz gekennzeichnet. Zurückhaltende Formen, die kunstvoll gerade Linien und weiche Rundungen vereinen, sind das Ergebnis eines langen Design- und Entwicklungsprozesses. Die zarten und klaren Linien verleihen den Produkten dieser Serie eine zeitgenössische Eleganz und einen Hauch von Luxus und Raffinesse, die zum klaren aber geschmackvollen Stil von GSI passen.





**Pura 102x52**  
Lavabo / Washbasin

**Pura 55x36**  
Wc-Bidet

**Pura 190x90**  
Vasca/Bath tub



















**Pura 100x50**  
Lavabo / Washbasin

**Pura 55x36**  
Wc-Bidet





Pura 55x36  
Wc-Bidet

**Pura 100x50**  
Lavabo / Washbasin

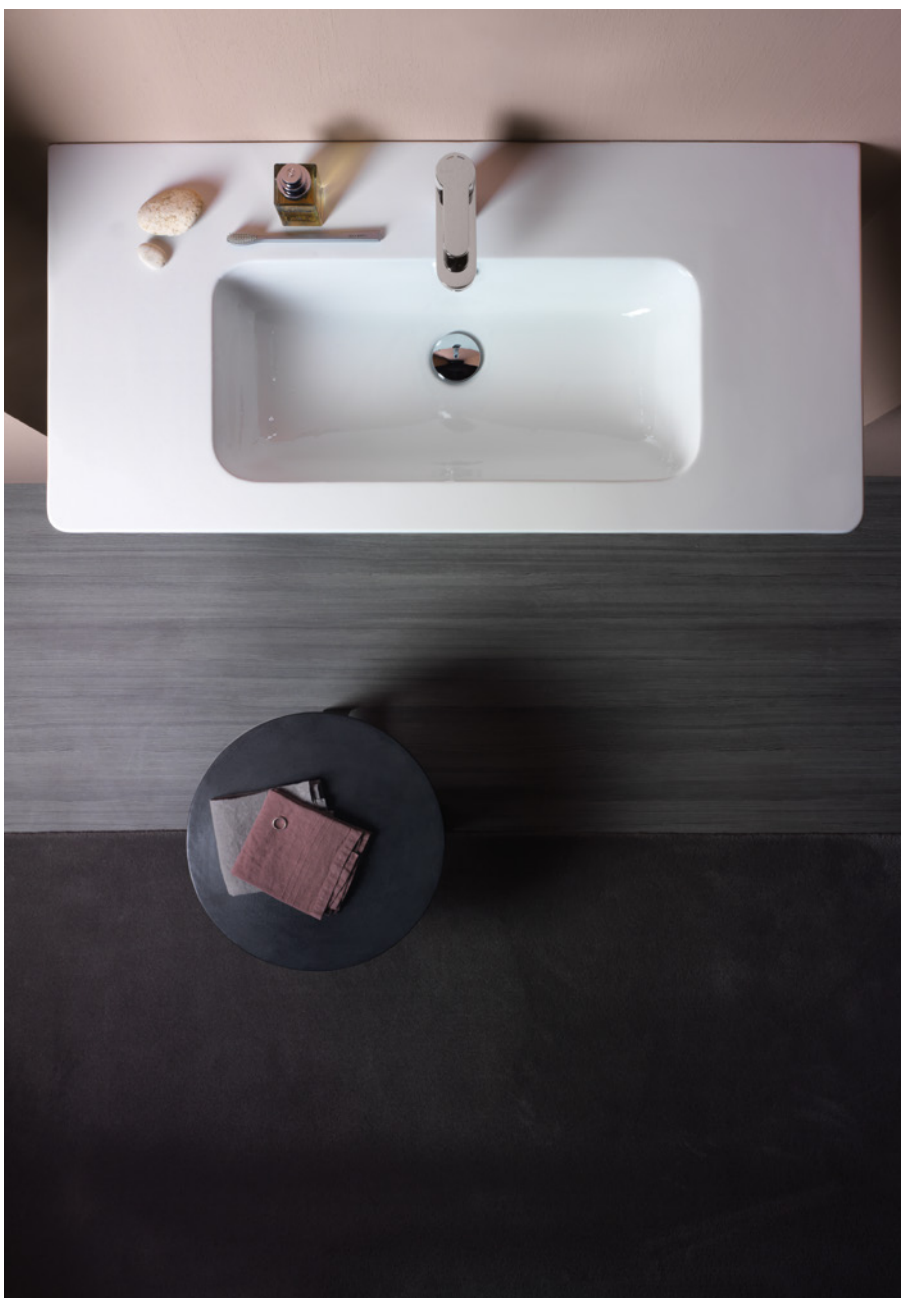











Pura 55x36  
Wc Swirflush







**Modo**

# Lavabi

## Washbasins

### Waschbecken

# Wc e Bidet

## Wc and Bidet

### Wc und Bidet

Modo

**120**

7724111

120x50

**100**

7723111

100x50

**80**

7722111

80x50

**65**

7732111

65x50

**50**

7785111

50x40

**55**

771211

7765111

55x38

**51**

771011

7760111

51x38



# Vasca

## Bathtub

## Badewanne

**190**

VAM95  
190x95





## Modo

La collezione Modo ha un aspetto inconfondibile, grazie ad un profilo dinamico, a linee pulite e proporzionate che integrano eleganza ed armonia in maniera seducente. Modo offre un elevato standard qualitativo grazie ad un attento bilanciamento tra design, materiali di alta qualità ed elementi di confort in grado di soddisfare le esigenze dell'utente. Lavabi con bacini capienti, predisposizione per l'aggiunta di portasciugamani, possibilità di installazioni multiple, sospensione, incasso su piano o mobile. Wc per installazione a sospensione, con sistema di scarico a 4,5 litri d' acqua e copriwater disponibili anche con sistema di chiusura rallentata (soft-close). Tutto della collezione Modo è stato pensato per soddisfare le esigenze dei clienti GSI.

The Modo collection has a unique shape which seductively combines elegance and harmony thanks to its dynamic outline and its simple, proportional lines. Modo ensures high quality standards thanks to the perfect balance between design, high quality materials and convenient features to meet users' needs. Washbasins have ample bowls, with the option to add a towel rail, and there are multiple configurations available, such as wall-hung, inset or on a base cabinet or free standing. Wall-hung Wc provided with 4,5 litre waste system and toilet seat also available with soft-closing system. In this collection GSI ceramics has invested all its efforts to satisfy customers' needs.

Die Modo Kollektion hat eine einzigartige Form, die auf verführerische Weise mit ihren dynamischen Konturen und den proportionalen Linien Eleganz und Harmonie kombiniert. Modo gewährleistet hohe Qualitätsmaßstäbe aufgrund des perfekten Ausgleichs zwischen design, hochwertigen Materialien und angenehmen Funktionen, die alle Anforderungen des Nutzers erfüllen. Die Waschbecken verfügen über weite Schalen und können optional mit einem Handtuchhalter ausgestattet werden. Sie sind als Wand-, Einbau-, Aufsatzwaschbecken und freistehende Waschbecken erhältlich. Das wandhängende WC mit 4,5 l Spülsystem ist auch mit WC-Sitz mit Soft Close-Mechanismus erhältlich. In dieser Kollektion bietet GSI Ceramica alles, was die Kundenanforderungen erfüllt.





Modo 120x50  
Lavabo / Washbasin



Modo 190x95  
Vasca / Bath tub





**Modelo 120x50**  
Lavabo / Washbasin

**Modo 190x95**  
Vasca/Bath tub







**Modo 51x38**  
Wc-Bidet



**Classic**

# Lavabi

## Washbasins

## Waschbecken

Classic

**125****8725111**

125x54

**60/T****874911**

60x40

**55/U****724311**

55x38

**105****8723111**

105x54

**50/U****724711**

50x35

**90****8788111**

90x50

**75****8787111**

75x50

**60****8731111**

60x46



# Wc e Bidet Wc and Bidet Wc und Bidet

# Vasca Bathtub Badewanne

**55**

871211  
8765111  
55x37



**54**

871011  
871111  
8762111  
54x37



**175**

VAL1  
VAL2  
175x82



**70**

871711  
70x37



## Classic

La collezione Classic esprime l'idea di eleganza secondo GSI ceramica attraverso un linguaggio subito riconoscibile per i tratti stilistici richiamati dai prodotti che fanno parte della famiglia di sanitari.

Un linguaggio non a caso classico che caratterizza sia i lavabi che i sanitari e la vasca da bagno con forme equilibrate ed armoniose di chiara ispirazione neoclassica. Prodotti senza tempo, dunque, che possono arredare l'ambiente bagno ricreando atmosfere tradizionali di eleganza e stile, ed in grado di evocare nuove forme di romanticismo così come dimostrano i nuovi sanitari sospesi.

The Classic collection exudes GSI's interpretation of elegance through the immediately recognizable stylistic traits of this product range: the classic shape of the washbasins, toilets, bidets and bath tubs, the products have balanced, harmonious shapes with obvious neoclassical inspiration. These are timeless products, which can furnish the bathroom recreating traditional atmosphere of stylish elegance, and to evoke new forms of romanticism as reflected in the new wall-hung sanitaryware.

Die Classic Kollektion verströmt die Eleganz nach der Interpretation von GSI über die sofort erkennbaren Stilmerkmale der Produktreihe: Als klassische Form der Waschbecken, WCs, Bidets und Badewannen haben die Produkte eine ausgewogene, harmonische Gestalt und sind offensichtlich vom Neoklassizismus inspiriert. Sie sind zeitlose Produkte, die Badezimmer mit einer traditionellen Atmosphäre stilvoller Eleganz ausstatten und neue romantische Formen wie in der neuen wandhängenden Sanitärkeramik aufweisen.





**Classic 75x50**  
Lavabo/Washbasin

**Classic 54x37**  
Wc-Bidet

**Classic 175x82**  
Vasca/Bath tub







**Classic 175x82**  
Vasca/Bathub



**Classic 55x37**  
Wc-Bidet





Classic 125x34  
Lavabo/Washbasin

Classic 54x37  
Wc-Bidet





**Classic 105x54**  
Lavabo/Washbasin

**Classic 70x37**  
Monoblocco / Close coupled

**Classic 54x37**  
Bidet



**Classic 90x50**  
Lavabo / Washbasin

**Classic 54x37**  
Mc-Bidet







**Community**

# Lavabi

## Washbasins

## Waschbecken

# Wc e Bidet

## Wc and Bidet

## Wc und Bidet

Community

**70**

7631011

70x60



**70**

761811

70x37



# Orinatoio

## Urinal

## Urinal

# Piatti doccia H6

## Shower trays H6

## H6 Duschwannen

**39****769711**

39x31

**140****358711**

140x80

**90/q****339711**

90x90

**120****359811**

120x80

**80/q****338611**

80x80

**120****359911**

120x70

**90****349711**

90x90

**100****358611**

100x80

**80****348611**

80x80

**100****358911**

100x70

**90****359711**

90x72



## Community

Community è la proposta GSI ceramica per l'ambiente bagno pubblico e collettivo. Si tratta di una collezione di sanitari che offre delle soluzioni molto particolari sia in termini di design che dal punto di vista delle possibilità di impiego. Community prevede una linea di prodotti per un'utenza diversamente abile.

Community is GSI's product range for the public environment. The collection offers specific solutions in terms of design and use. The Community collection includes a series for disabled users.

Community ist die Produktserie von CSI für öffentliche Bereiche. Die Kollektion bietet besondere Lösungen hinsichtlich Design und Gebrauch. Zu der Community Kollektion gehört auch eine Serie für behinderte Nutzer.







**Community 70x60**  
Lavabo / Washbasin



**Community 70x37**  
Wc

**H6 120x80**  
Piatto doccia / Shower tray



**Community 70x60**  
Lavabo / Washbasin



**Community 70x37**  
WC





**H6 120x80**  
Platto doccia / Shower tray





**H6 80x80**  
Platto doccia / Shower tray

**H6 90x90**  
Platto doccia / Shower tray



Disegni tecnici  
Technical drawings  
Technische  
Zeichnungen

**Sand**

# Lavabi

## Element Free

### Washbasins

## Element Free

### Element Free

## Waschbecken

Sand

## h85

Description	Washbasin
Code	<b>905811</b>
	<b>905911</b>
Dimensions	55x38 h85
Weight	Kg 47
Capacity	Lt 11
Overflow	CL 00
Installation	freestanding
Taphole	0

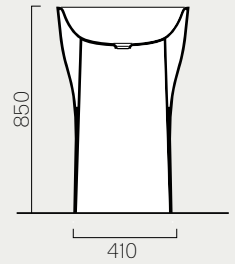
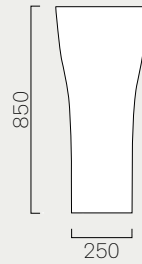
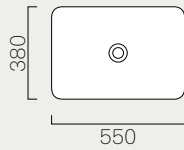

# Lavabi

## Washbasins

## Waschbecken

### 125

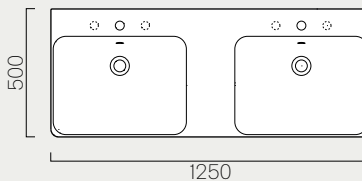

Description	Washbasin
Code	9052111
Dimensions	125x50 h19
Overflow	CL 25
Installation	Wall-hung, built-in
Taphole	1 (3)

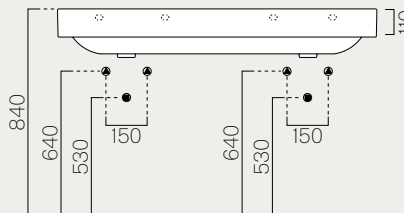
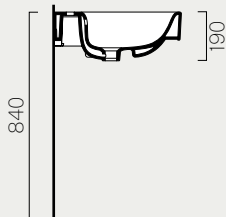

### 120

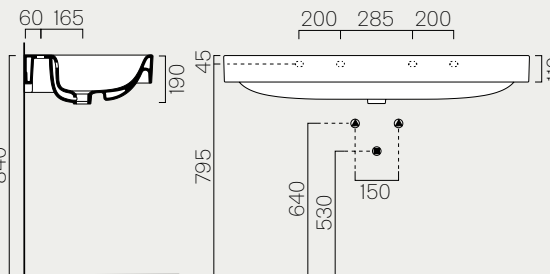
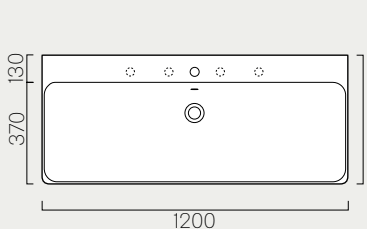

Description	Washbasin
Code	9024111
Dimensions	120x50 h19
Weight	Kg 33,7
Capacity	Lt 20
Overflow	CL 25
Installation	Wall-hung, built-in
Taphole	1 (5)



## 100

Description	Washbasin
Code	<b>9023111</b>
Dimensions	100x50 h19
Weight	Kg 28,7
Capacity	Lt 18,5
Overflow	CL 25
Installation	Wall-hung, built-in
Taphole	1(5)

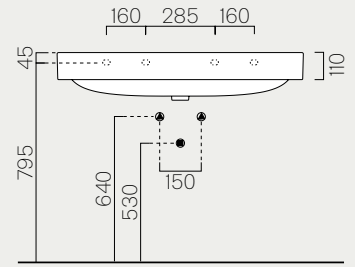
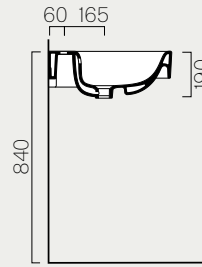
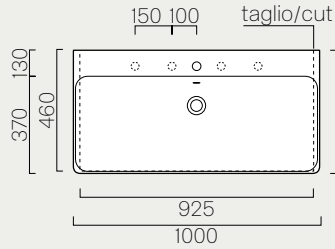

## 100

Description	Washbasin
Code	<b>9051111</b>
Dimensions	100x50 h19
Weight	Kg 29
Capacity	Lt 9
Overflow	CL 25
Installation	Wall-hung, built-in
Taphole	1(3)

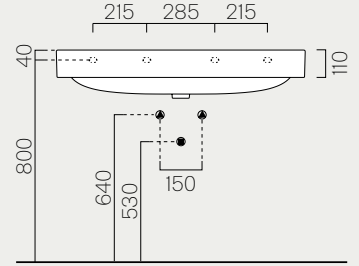
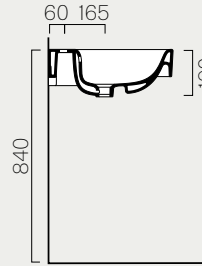
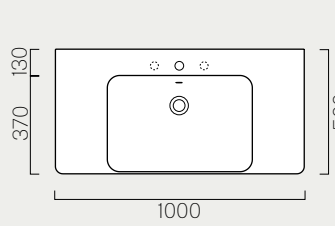

## 80

Description	Washbasin
Code	<b>9022111</b>
Dimensions	80x50 h19
Weight	Kg 23,7
Capacity	Lt 14
Overflow	CL 25
Installation	Wall-hung, built-in
Taphole	1(3)

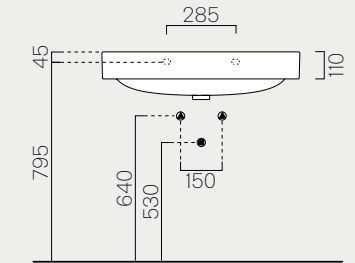
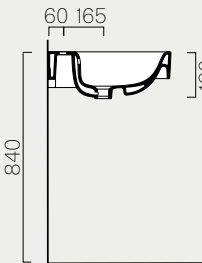
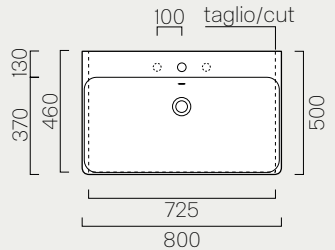

## 60

Description	Washbasin
Code	<b>9031111</b>
Dimensions	60x50 h19
Weight	Kg 18,5
Capacity	Lt 9
Overflow	CL 25
Installation	Wall-hung, built-in
Taphole	1(3)

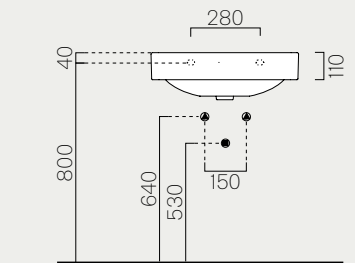
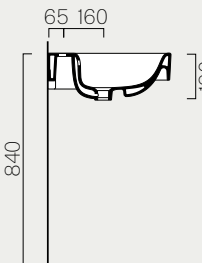
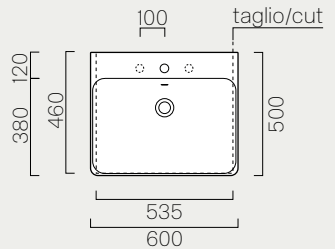

50

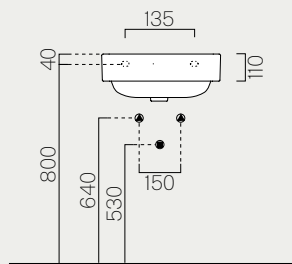
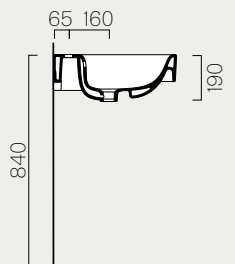
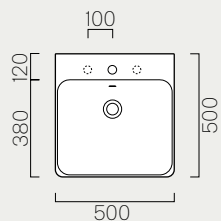

Description	Washbasin
Code	<b>9085111</b>
Dimensions	50x50 h19
Weight	Kg 15,7
Capacity	Lt 14,5
Overflow	CL 25
Installation	Wall-hung, built-in
Taphole	1 (3)

70

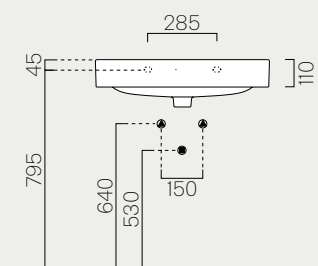
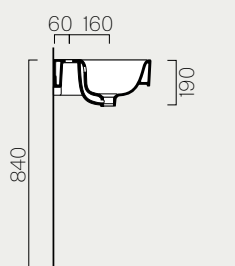
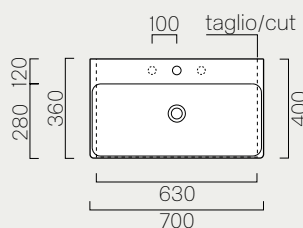

Description	Washbasin
Code	<b>9087111</b>
Dimensions	70x40 h19
Weight	Kg 16,5
Capacity	Lt 9
Overflow	CL 25
Installation	Wall-hung, built-in
Taphole	1 (3)

55

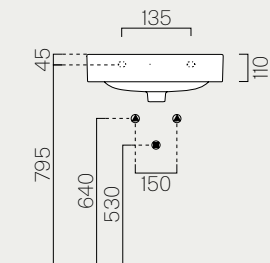
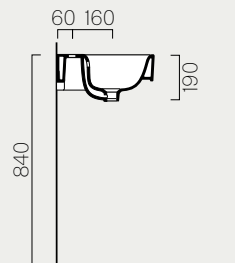
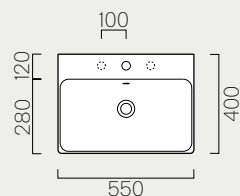

Description	Washbasin
Code	<b>9086111</b>
Dimensions	55x40 h19
Weight	Kg 12,7
Capacity	Lt 7
Overflow	CL 25
Installation	Wall-hung, built-in
Taphole	1 (3)

40

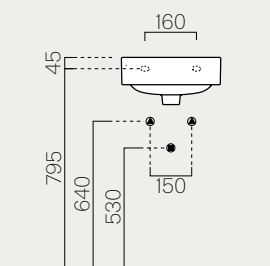
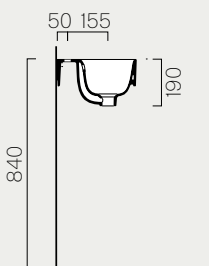
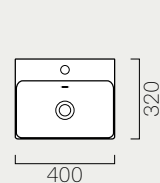

Description	Washbasin
Code	<b>9084111</b>
Dimensions	40x32 h19
Weight	Kg 9,5
Capacity	Lt 4,5
Overflow	CL 25
Installation	Wall-hung, built-in
Taphole	1

## 60/TS

Description	Washbasin
Code	<b>908311</b>
Dimensions	60x38 h14
Weight	Kg 12,4
Capacity	Lt 8,5
Overflow	CL 00
Installation	Countertop
Taphole	0

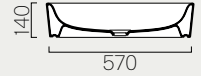
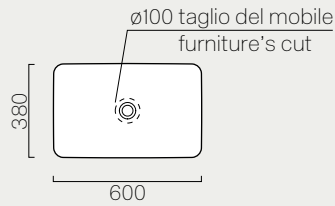

## 50/TS

Description	Washbasin
Code	<b>908211</b>
Dimensions	50x38 h14
Weight	Kg 10,8
Capacity	Lt 6
Overflow	CL 00
Installation	Countertop
Taphole	0

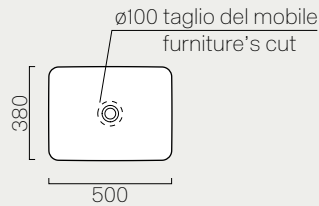

## 48/TS

Description	Washbasin
Code	<b>903511</b>
Dimensions	48 h14
Weight	Kg 11
Capacity	Lt 7,5
Overflow	CL 00
Installation	Countertop
Taphole	0

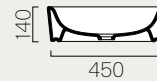

## 42/TS

Description	Washbasin
Code	<b>904811</b>
Dimensions	42 h14
Weight	Kg 9,4
Capacity	Lt 4,5
Overflow	CL 00
Installation	Countertop
Taphole	0



# 70/TO

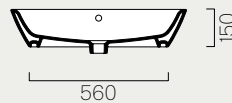
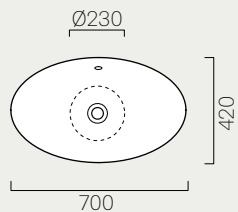

Description	Washbasin
Code	<b>904111</b>
Dimensions	70x42 h15
Weight	Kg 14,2
Capacity	Lt 8,5
Overflow	CL 25
Installation	Countertop
Taphole	0

# 60/TO

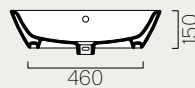
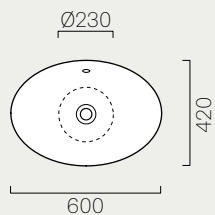

Description	Washbasin
Code	<b>904911</b>
Dimensions	60x42 h15
Weight	Kg 12
Capacity	Lt 7
Overflow	CL 25
Installation	Countertop
Taphole	0

# 42/TO

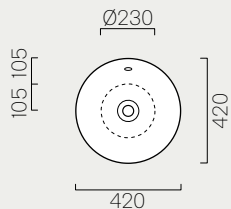

Description	Washbasin
Code	<b>902811</b>
Dimensions	42 h15
Weight	Kg 9,1
Capacity	Lt 4,5
Overflow	CL 25
Installation	Countertop
Taphole	0

# 70/TE

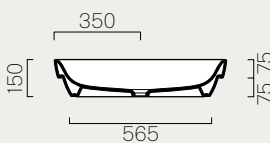
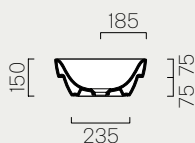
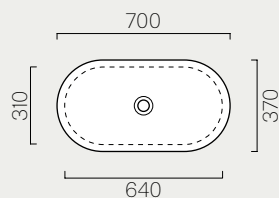

Description	Washbasin
Code	<b>908911</b>
Dimensions	70x37 h15
Weight	Kg 13,3
Capacity	Lt 11
Overflow	CL 00
Installation	Countertop, Built-in
Taphole	0

**55/TE**

Description	Washbasin
Code	<b>903011</b>
Dimensions	55x35 h15
Weight	Kg 9,7
Capacity	Lt 6
Overflow	CL 00
Installation	Countertop, Built-in
Taphole	0

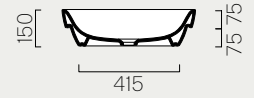
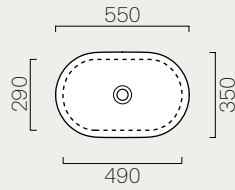
**45/TE**

Description	Washbasin
Code	<b>903411</b>
Dimensions	45 h15
Weight	Kg 9,6
Capacity	Lt 7
Overflow	CL 00
Installation	Countertop, Built-in
Taphole	0

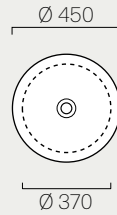
**35/TE**

Description	Washbasin
Code	<b>905011</b>
Dimensions	35 h15
Weight	Kg 6
Capacity	Lt 4,5
Overflow	CL 00
Installation	Countertop, Built-in
Taphole	0

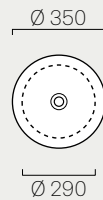
**60/1**

Description	Washbasin
Code	<b>9033111</b>
Dimensions	60x45 h16
Weight	Kg 13,5
Capacity	Lt 4,5
Overflow	CL 25
Installation	Built-in
Taphole	1

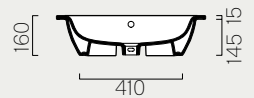
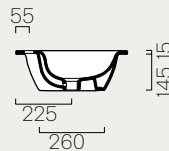
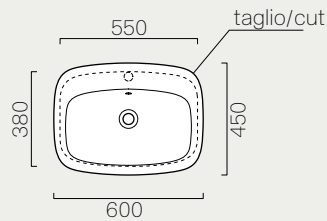

# Wc e Bidet

## Wc and Bidet

## Wc und Bidet

55

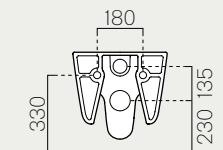
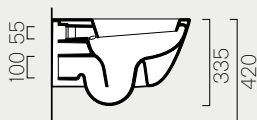
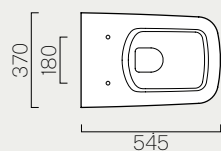

Description	Wc
Code	901211
Dimensions	54,5x37
Weight	Kg 21,3
Flush system	Standard
Installation	wall-hung

55

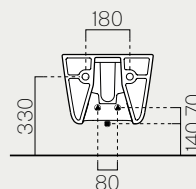
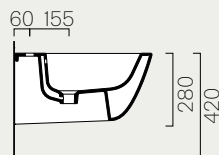
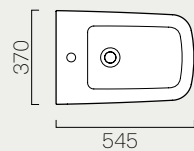

Description	Bidet
Code	906511
Dimensions	54,5x37
Weight	Kg 17,3
Overflow	CL 25
Installation	wall-hung
Taphole	1

55/F

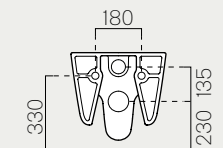
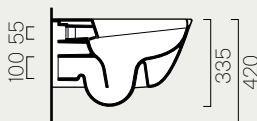
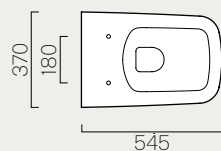

Description	Wc
Code	901511
Dimensions	54,5x37
Weight	Kg 20,5
Flush system	Swirlflush
Installation	wall-hung

# 50

Description	Wc
Code	<b>901811</b>
Dimensions	50x37
Weight	Kg 19,5
Flush system	Standard
Installation	wall-hung

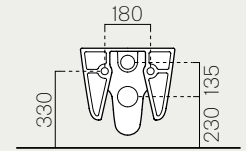
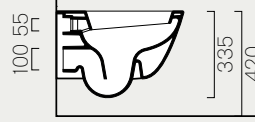
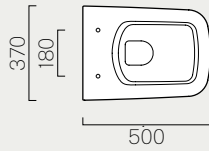

# 50

Description	Bidet
Code	<b>906411</b>
Dimensions	50x37
Weight	Kg 15,9
Overflow	CL 25
Installation	wall-hung
Taphole	1

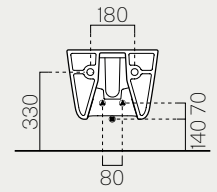
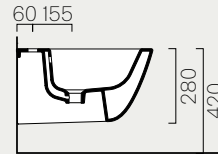
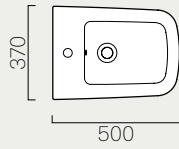

# 50/F

Description	Wc
Code	<b>901611</b>
Dimensions	51x37
Flush system	Swirlflush
Installation	wall-hung

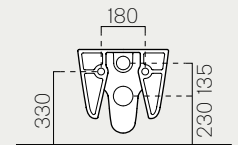
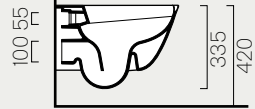
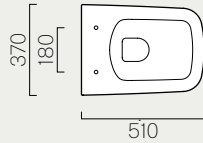

# 55

Description	Wc
Code	<b>901411</b>
Dimensions	54,5x37
Weight	Kg 26
Flush system	Standard
Installation	Floor standing

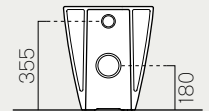
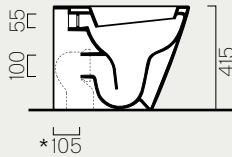
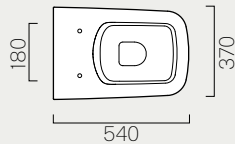

**Curva tecnica**  
Technical curve

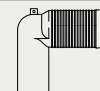

**Codice**  
Codes

MCURVA

MCURVAS

MCURVA90

**Interasse**  
Distance

\* 105

\* Da 165 a 180 mm  
\* From 165 to 180 mm

\* Da 60 a 80 mm  
\* From 60 to 80 mm

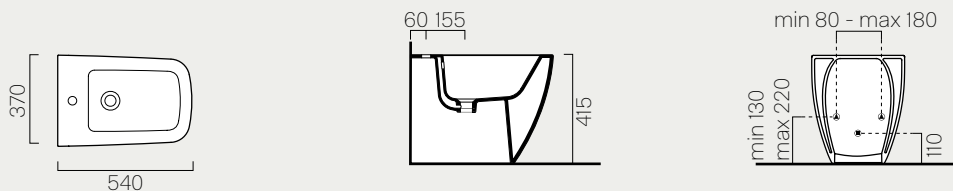

Description	Bidet
Code	9062111
Dimensions	54,5x37
Weight	Kg 23,1
Overflow	CL 25
Installation	Floor standing
Taphole	1

# Vasca

## Bathtub

## Badewanne

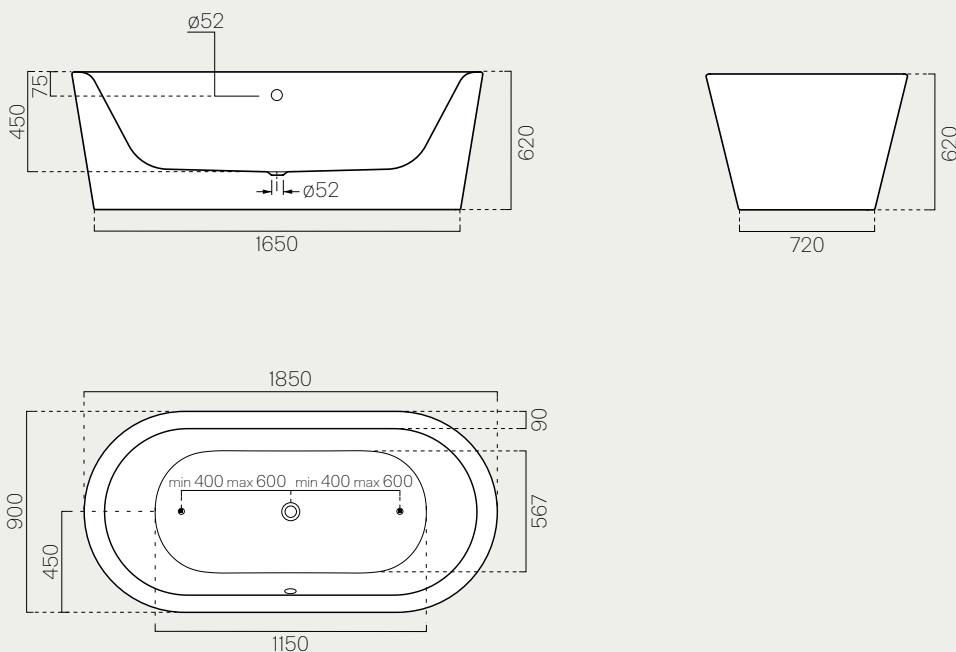

185

Description	Bathtub
Code	VASAND90
Dimensions	185X90 h62
Weight	Kg 58
Installation	freestanding
Material	acrylic



# 180

Description	Bathtub
Code	<b>VASAND80</b>
Dimensions	180X80 h45
Weight	Kg 36
Installation	Built-in
Material	acrylic

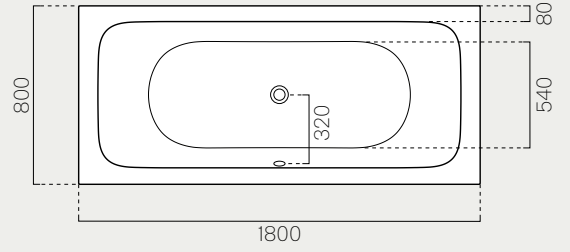
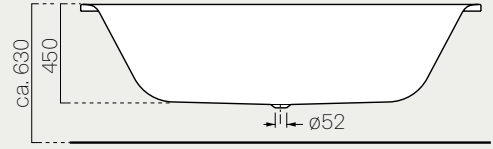

Disegni tecnici  
Technical drawings  
Technische  
Zeichnungen

**Norm**

# Lavabi

## Element Free

### Washbasins

## Element Free

### Element Free

## Waschbecken

Norm

## h85

Description	Washbasin
Code	<b>7559011</b>
	<b>7558011</b>
Dimensions	56x40 h85
Weight	Kg 47,2
Capacity	Lt 14
Overflow	CL 00
Installation	freestanding
Taphole	0

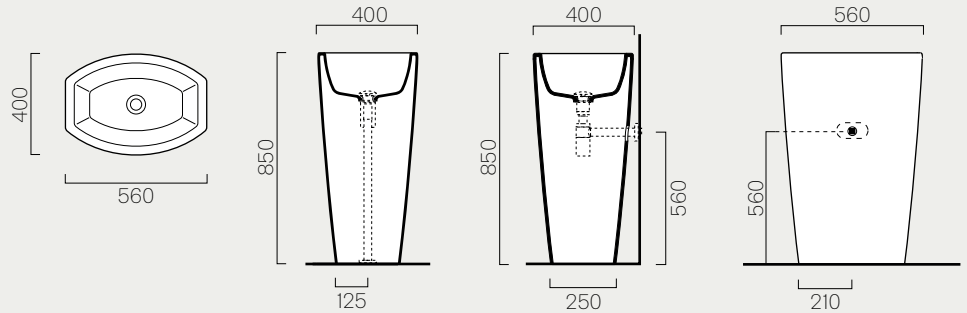

## h85

Description	Washbasin
Code	<b>7557111</b>
	<b>7556111</b>
Dimensions	56x40 h85
Weight	Kg 49
Capacity	Lt 10
Overflow	CL 25
Installation	freestanding
Taphole	1

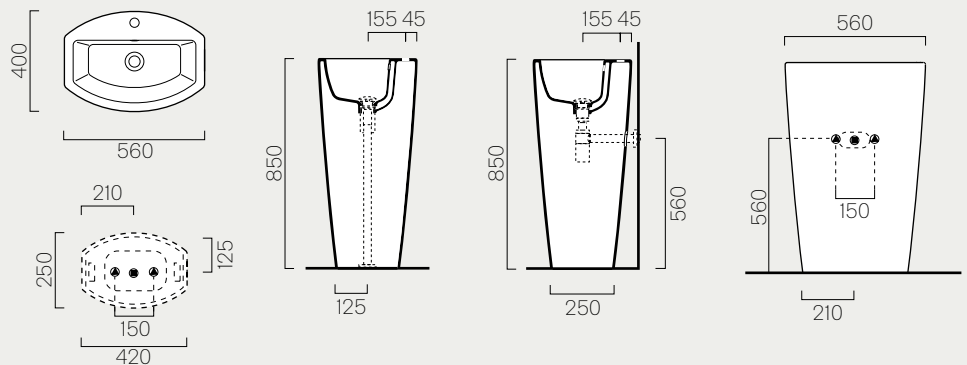

# Lavabi

## Washbasins

## Waschbecken

## 125

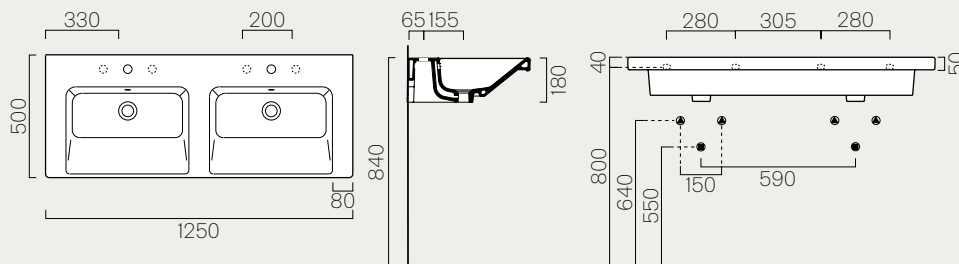

Description	Washbasin
Code	<b>8625111</b>
Dimensions	125x50 h18
Weight	Kg 34,8
Capacity	Lt 8
Overflow	CL 25
Installation	wall-hung, built-in
Taphole	1 (3)

## 120

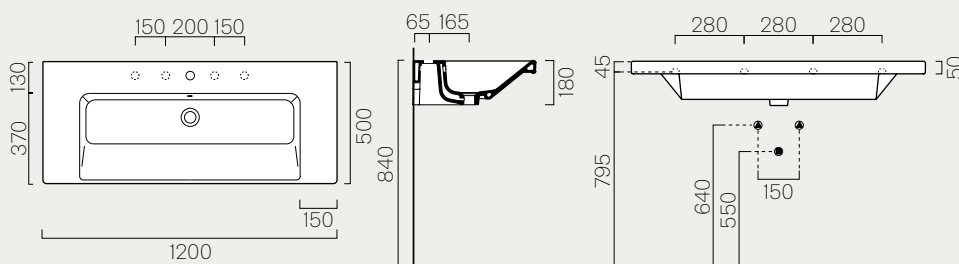

Description	Washbasin
Code	<b>8624111</b>
Dimensions	120x50 h18
Weight	Kg 30
Capacity	Lt 14
Overflow	CL 25
Installation	wall-hung, built-in
Taphole	1 (5)

## 100

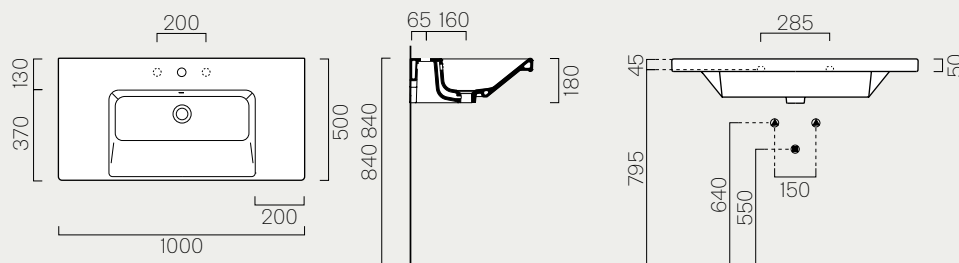

Description	Washbasin
Code	<b>8623111</b>
Dimensions	100x50 h18
Weight	Kg 26
Capacity	Lt 9,5
Overflow	CL 25
Installation	wall-hung, built-in
Taphole	1 (3)

## 90

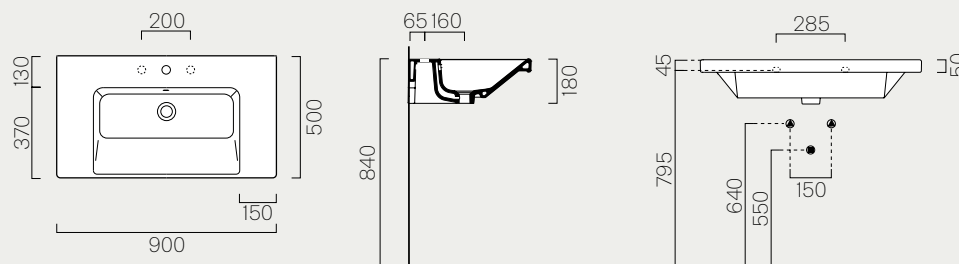

Description	Washbasin
Code	<b>8688111</b>
Dimensions	90x50 h18
Weight	Kg 24,6
Capacity	Lt 9,5
Overflow	CL 25
Installation	wall-hung, built-in
Taphole	1 (3)

## 75

Description	Washbasin
Code	<b>8687111</b>
Dimensions	75x50 h18
Weight	Kg 20,1
Capacity	Lt 8,5
Overflow	CL 25
Installation	wall-hung, built-in
Taphole	1 (3)

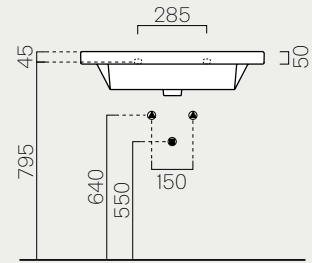
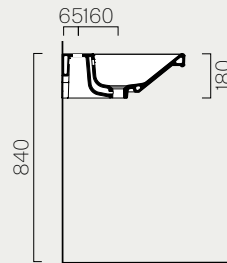
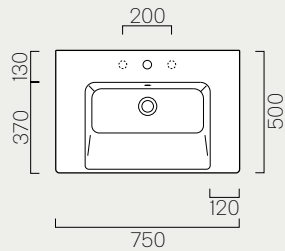

## 60

Description	Washbasin
Code	<b>8683111</b>
Dimensions	60x50 h18
Weight	Kg 18,1
Capacity	Lt 6,5
Overflow	CL 25
Installation	wall-hung, built-in
Taphole	1 (3)

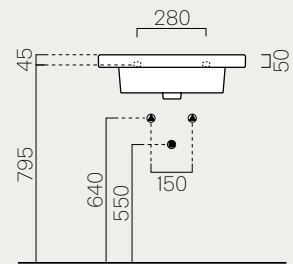
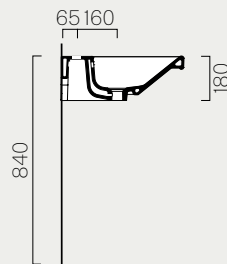
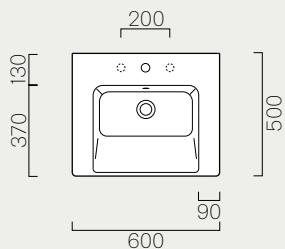

## 42

Description	Washbasin
Code	<b>8684111</b>
Dimensions	42x34 h17
Weight	Kg 9,1
Capacity	Lt 3
Overflow	CL 25
Installation	wall-hung, built-in
Taphole	1

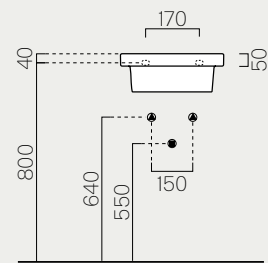
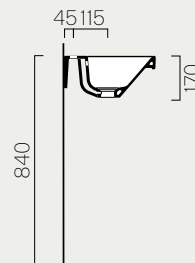
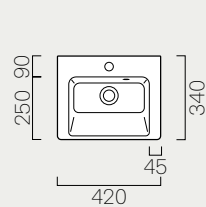

## 35

Description	Washbasin
Code	<b>8650111</b>
Dimensions	35x26 h12
Weight	Kg 5,6
Capacity	Lt 1,8
Overflow	CL 00
Installation	wall-hung, built-in
Taphole	1

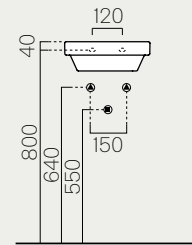
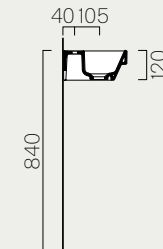
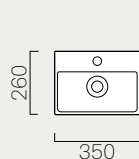

# Wc e Bidet

## Wc and Bidet

## Wc und Bidet

55

Norm

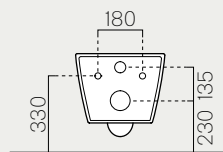
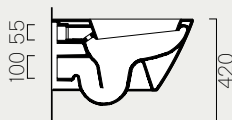
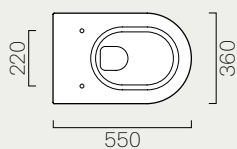

Description	Wc
Code	<b>861211</b>
Dimensions	55x36
Weight	Kg 24
Flush system	Standard
Installation	wall-hung

55

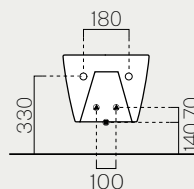
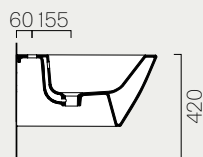
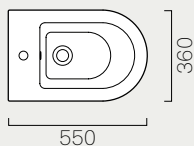

Description	Bidet
Code	<b>861511</b>
Dimensions	55x36
Weight	Kg 16,3
Overflow	CL 25
Installation	wall-hung
Taphole	1

55/F

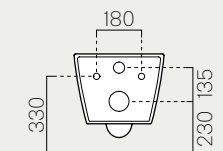
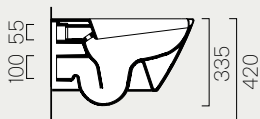
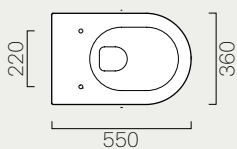

Description	Wc
Code	<b>861511</b>
Dimensions	55x36
Weight	Kg 23,7
Flush system	Swirflush
Installation	wall-hung

# 50

Description	Wc
Code	<b>861811</b>
Dimensions	50x36
Weight	Kg 16,5
Flush system	Standard
Installation	wall-hung

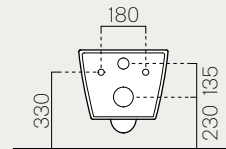
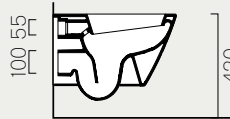
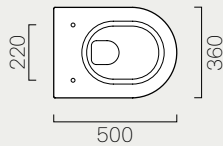

Norm

# 50

Description	Bidet
Code	<b>8664111</b>
Dimensions	50x36
Weight	Kg 15,3
Overflow	CL 25
Installation	wall-hung
Taphole	1

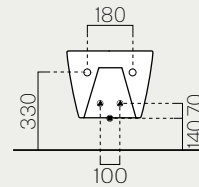
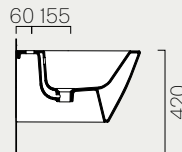
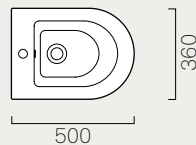

# 50/F

Description	Wc
Code	<b>861611</b>
Dimensions	50x36
Weight	Kg 22,3
Flush system	Swirflush
Installation	wall-hung

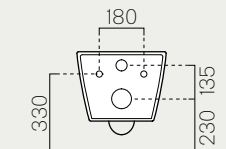
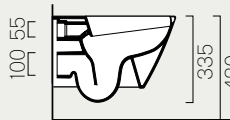
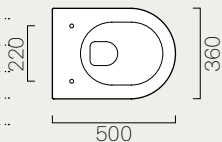

# 45

Description	Wc
Code	<b>861011</b>
Dimensions	45x35
Weight	Kg 18,6
Flush system	Standard
Installation	wall-hung

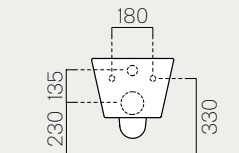
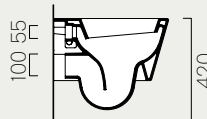
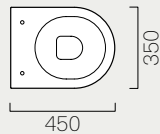

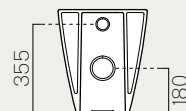
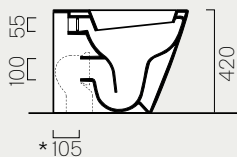
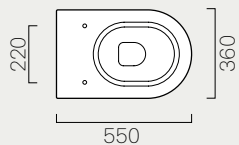

Description	Wc
Code	<b>861411</b>
Dimensions	55x36
Weight	Kg 24,8
Flush system	Standard
Installation	Floor standing

**Curva tecnica**  
Technical curve



**Codice**

MCURVA

MCURVA90

Codes

**Interasse**  
Distance

\* 105

\* 60

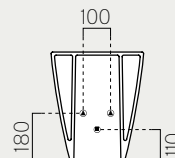
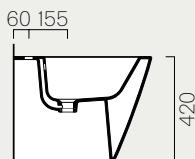
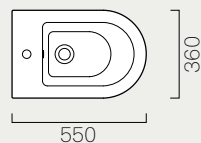

Description	Bidet
Code	<b>8662111</b>
Dimensions	55x36
Weight	Kg 20,8
Overflow	CL 25
Installation	Floor standing
Taphole	1

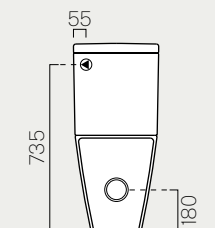
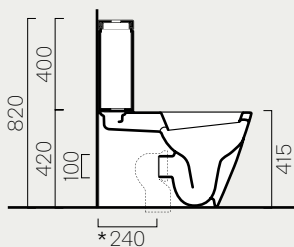
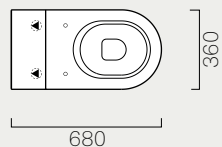

Description	Wc
Code	<b>861711</b>
Dimensions	68x36
Weight	Kg 31,8
Flush system	Standard
Installation	Floor standing

Vista dal retro.  
View from the back.  
Blick von hinten.

**Curva tecnica**  
Technical curve



**Codice**

MCURVAS

MCURVA90

Codes

**Interasse**  
Distance

\* Da 230 a 305 mm  
\* From 230 to 305 mm

\* Da 80 a 205 mm  
\* From 80 to 205 mm



# Cassetta

Description	Cistern
Code	<b>868111</b>
Dimensions	17x31 43h
Weight	Kg 13,5

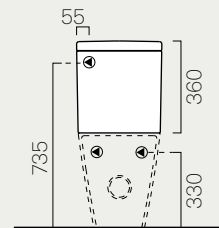
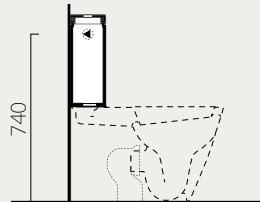
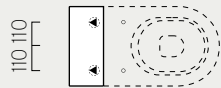

Vista dal retro.  
View from the back.  
Blick von hinten.

# Scocca

Description	Ceramic Cover
Code	<b>869111</b>
Dimensions	13x35,5 46h
Weight	Kg 9,6

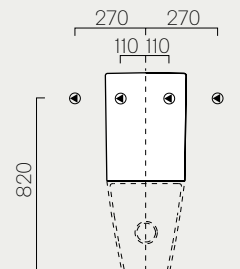
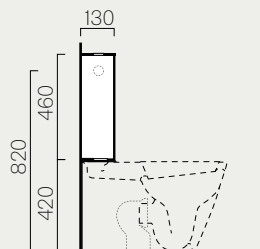

Vista dal retro.  
View from the back.  
Blick von hinten.

Disegni tecnici  
Technical drawings  
Technische  
Zeichnungen

**Kube**

# Lavabi

## Washbasins

## Waschbecken

### 150

Description	Washbasin
Code	<b>8963111</b>
Dimensions	150x50 h16
Weight	Kg 40,5
Capacity	Lt 9
Overflow	CL 25
Installation	wall-hung, countertop
Taphole	1(3)

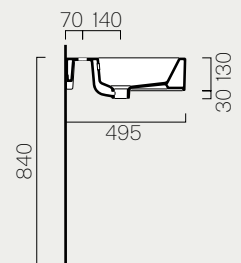
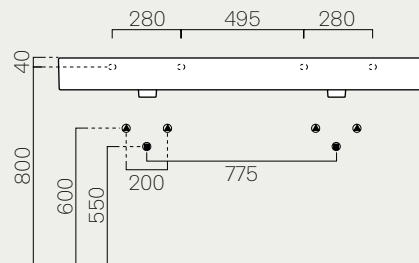
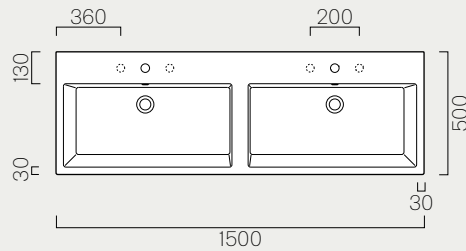

# 120

Description	Washbasin
Code	<b>8924111</b>
Dimensions	120x47 h16
Weight	Kg 28,7
Capacity	Lt 13,5
Overflow	CL 25
Installation	wall-hung, countertop
Taphole	1 (5)

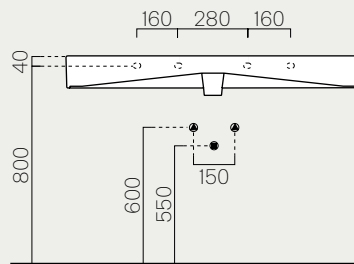
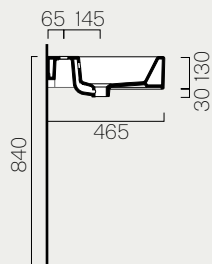
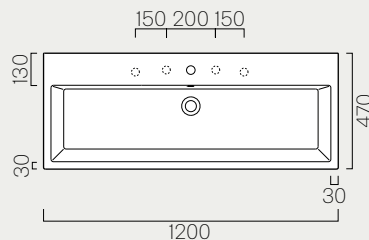

# 120

Description	Washbasin
Code	<b>8952111</b>
Dimensions	120x47 h16
Weight	Kg 28
Capacity	Lt 8
Overflow	CL 25
Installation	wall-hung, countertop
Taphole	1 (3)

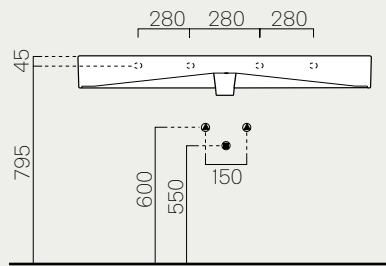
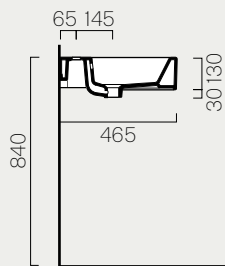
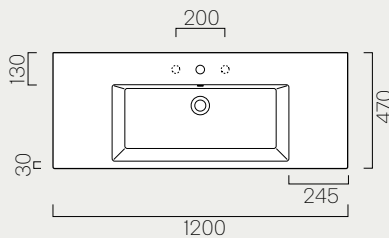

## 100

Description	Washbasin
Code	<b>8923111</b>
Dimensions	100x47 h16
Weight	Kg 23,5
Capacity	Lt 12
Overflow	CL 25
Installation	wall-hung, countertop
Taphole	1(5)

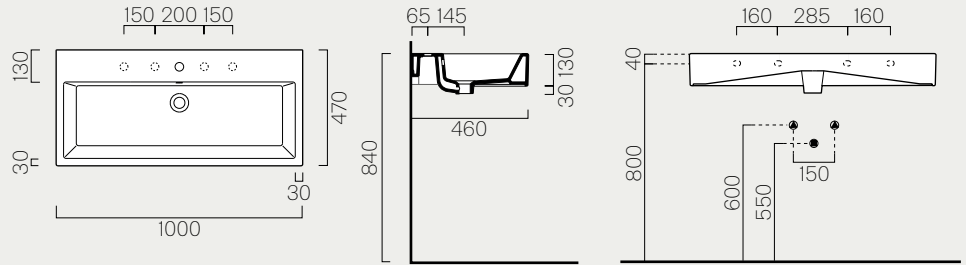

## 100

Description	Washbasin
Code	<b>8951111</b>
Dimensions	100x47 h16
Weight	Kg 27,4
Capacity	Lt 6
Overflow	CL 25
Installation	wall-hung, countertop
Taphole	1(3)

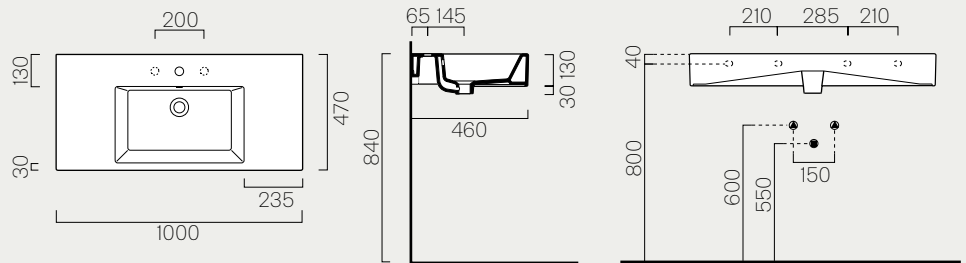

## 80

Description	Washbasin
Code	<b>8922111</b>
Dimensions	80x47 h16
Weight	Kg 21,6
Capacity	Lt 8,5
Overflow	CL 25
Installation	wall-hung, countertop
Taphole	1(3)

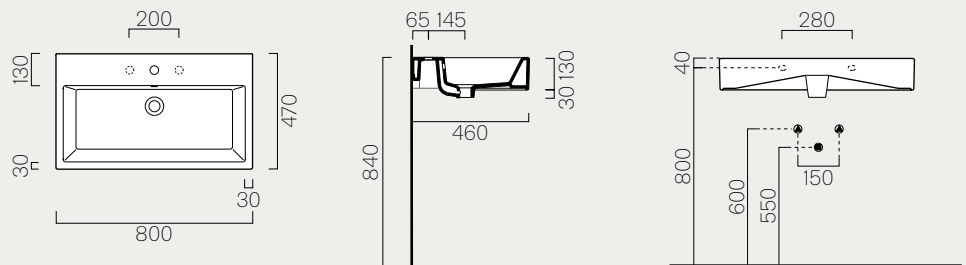

## 80/d

Description	Washbasin
Code	<b>8956111</b>
Dimensions	80x47 h16
Weight	Kg 20,3
Capacity	Lt 6
Overflow	CL 25
Installation	wall-hung, countertop
Taphole	1(3)

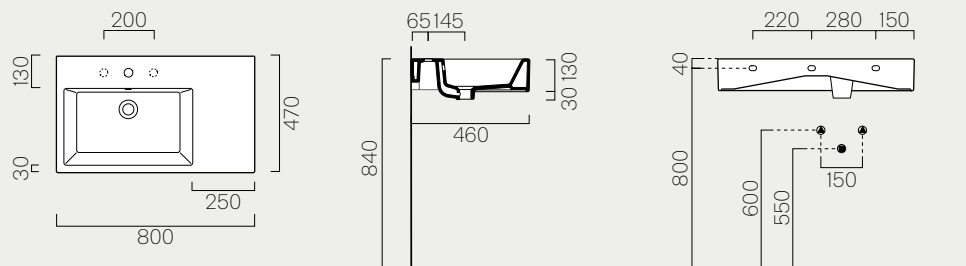

Vista dal retro.  
View from the back.  
Blick von hinten.

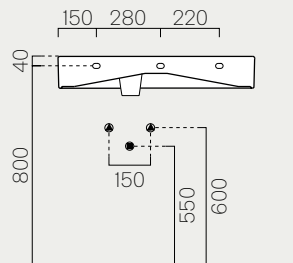
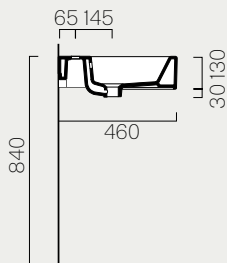
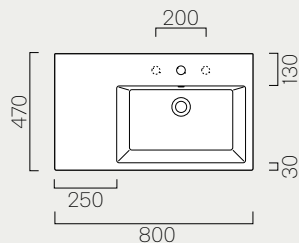
**80/s**

Description	Washbasin
Code	<b>8957111</b>
Dimensions	80x47 h16
Weight	Kg 20,3
Capacity	Lt 6
Overflow	CL 25
Installation	wall-hung, countertop
Taphole	1 (3)

Vista dal retro.  
View from the back.  
Blick von hinten.

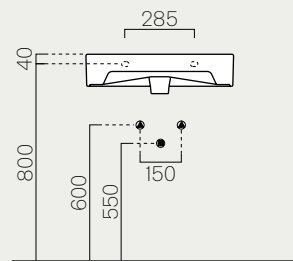
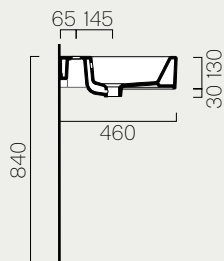
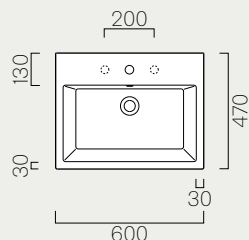
**60**

Description	Washbasin
Code	<b>8931111</b>
Dimensions	60x47 h16
Weight	Kg 16,5
Capacity	Lt 6,5
Overflow	CL 25
Installation	wall-hung, countertop
Taphole	1 (3)

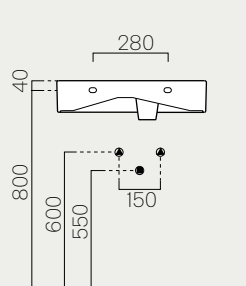
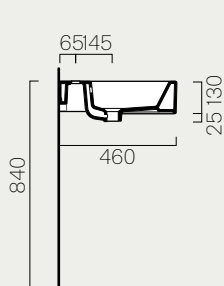
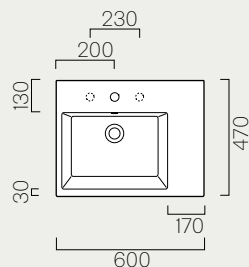
**60/d**

Description	Washbasin
Code	<b>8938111</b>
Dimensions	60x47 h16
Weight	Kg 16,9
Capacity	Lt 4,5
Overflow	CL 25
Installation	wall-hung, countertop
Taphole	1 (3)

Vista dal retro.  
View from the back.  
Blick von hinten.

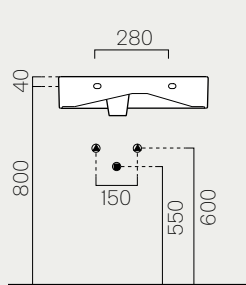
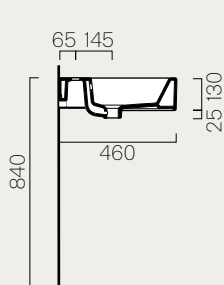
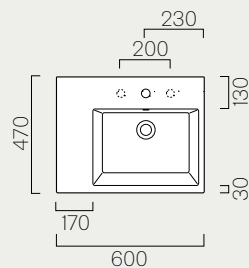
**60/s**

Description	Washbasin
Code	<b>8939111</b>
Dimensions	60x47 h16
Weight	Kg 16,9
Capacity	Lt 4,5
Overflow	CL 25
Installation	wall-hung, countertop
Taphole	1 (3)

Vista dal retro.  
View from the back.  
Blick von hinten.

## 50

Description	Washbasin
Code	<b>8930111</b>
Dimensions	50x47 h16
Weight	Kg 14,3
Capacity	Lt 5
Overflow	CL 25
Installation	wall-hung, countertop
Taphole	1 (3)

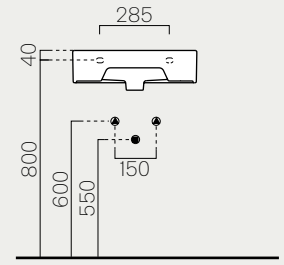
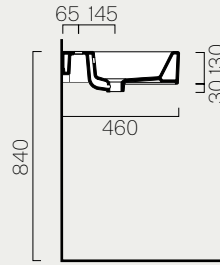
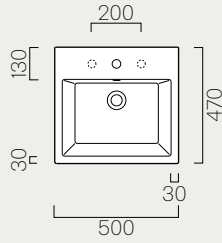

## 45

Description	Washbasin
Code	<b>8985111</b>
Dimensions	45x35 h13
Weight	Kg 10,4
Capacity	Lt 4
Overflow	CL 25
Installation	wall-hung, countertop
Taphole	1 (3)

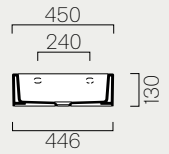
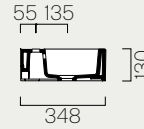
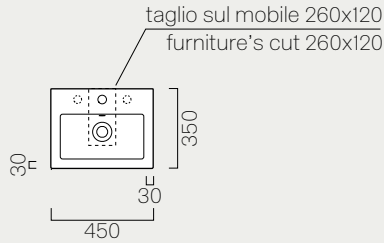

## 50

Description	Washbasin
Code	<b>8986011</b>
Dimensions	50x25 h13
Weight	Kg 10
Capacity	Lt 4
Overflow	CL 00
Installation	countertop
Taphole	0 (1)

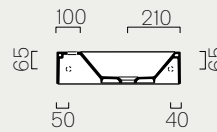
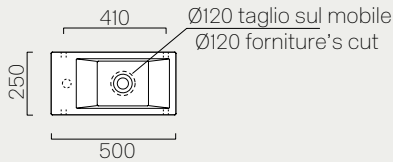

## 40

Description	Washbasin
Code	<b>8984011</b>
Dimensions	40x23 h1,5
Weight	Kg 7
Capacity	Lt 2
Overflow	CL 00
Installation	countertop
Taphole	0 (1)

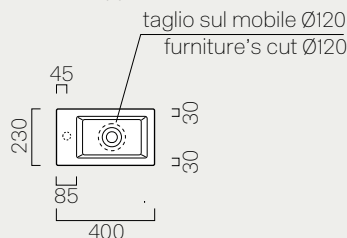
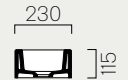
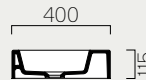
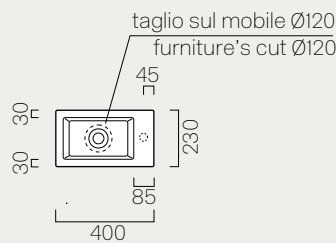

## 60/TS

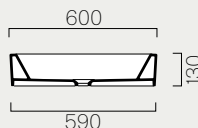
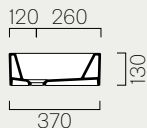
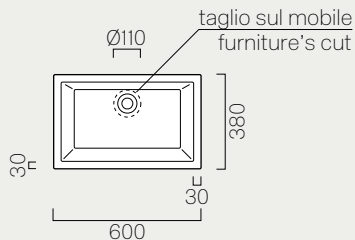

Description	Washbasin
Code	<b>8983011</b>
Dimensions	60x38 h13
Weight	Kg 15,6
Capacity	Lt 8,5
Overflow	CL 00
Installation	countertop
Taphole	0

## 50/TS

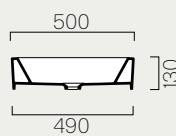
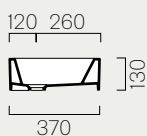
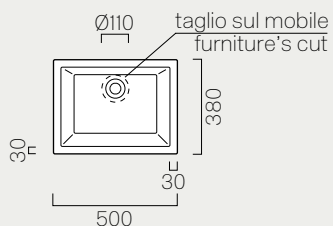

Description	Washbasin
Code	<b>8982011</b>
Dimensions	50x38 h13
Weight	Kg 10,7
Capacity	Lt 7
Overflow	CL 00
Installation	countertop
Taphole	0

## 50/TI

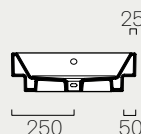
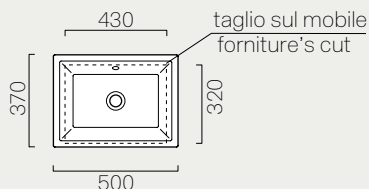

Description	Washbasin
Code	<b>894711</b>
Dimensions	50x37 h15,5
Weight	Kg 12,6
Capacity	Lt 4
Overflow	CL 25
Installation	countertop, built-in
Taphole	0

## 37/TI

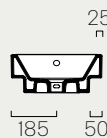
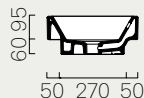
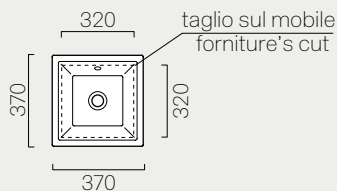

Description	Washbasin
Code	<b>895011</b>
Dimensions	37x37 h15,5
Weight	Kg 10
Capacity	Lt 3
Overflow	CL 25
Installation	countertop, built-in
Taphole	0



# 55/s

Description	Washbasin
Code	<b>8934111</b>
Dimensions	55x47 h15,5
Weight	Kg 16
Capacity	Lt 4
Overflow	CL 25
Installation	semi-recessed
Taphole	1 (3)

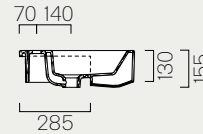
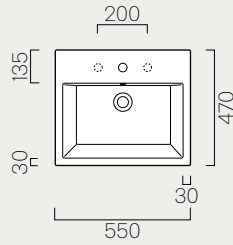

# 58/1

Description	Washbasin
Code	<b>8933011</b>
Dimensions	58x45 h16,5
Weight	Kg 14,6
Capacity	Lt 4
Overflow	CL 25
Installation	built-in
Taphole	0 (1)

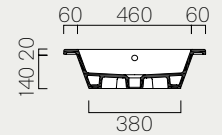
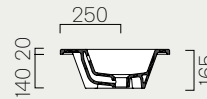
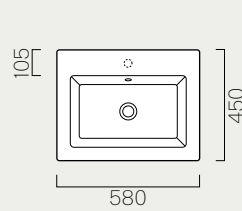

# Wc e Bidet

## Wc and Bidet

## Wc und Bidet

# 55

Description	Wc
Code	<b>891211</b>
Dimensions	55x36
Weight	Kg 20,4
Flush system	standard
Installation	wall-hung

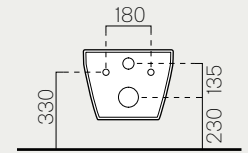
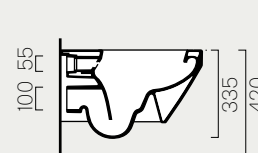
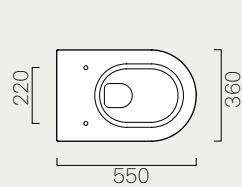

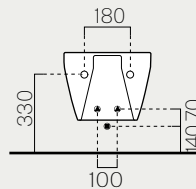
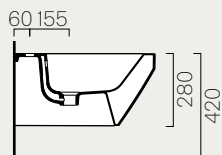
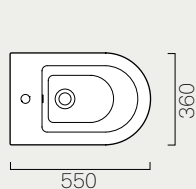
**55**

Description	Bidet
Code	<b>8965111</b>
Dimensions	55x36
Weight	Kg 16,4
Overflow	CL 25
Installation	wall-hung
Taphole	1

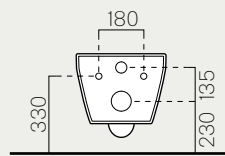
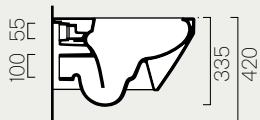
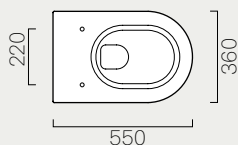
**55/F**

Description	Wc
Code	<b>8915111</b>
Dimensions	55x36
Weight	Kg 20,1
Flush system	swirlflush
Installation	wall-hung

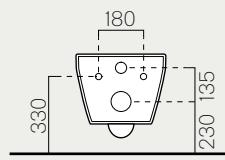
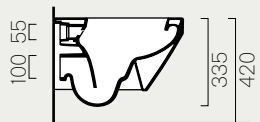
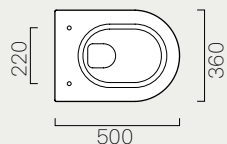
**50**

Description	Wc
Code	<b>8918111</b>
Dimensions	50x36
Weight	Kg 18,2
Flush system	standard
Installation	wall-hung

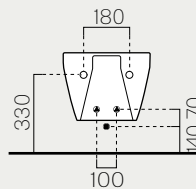
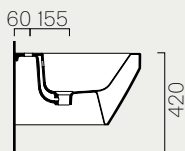
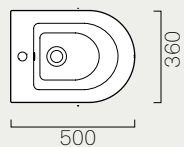
**50**

Description	Bidet
Code	<b>8964111</b>
Dimensions	50x36
Weight	Kg 16,2
Overflow	CL 25
Installation	wall-hung
Taphole	1

**50/F**

Description	Wc
Code	<b>891611</b>
Dimensions	50x36
Weight	Kg 20,2
Flush system	swirlflush
Installation	wall-hung

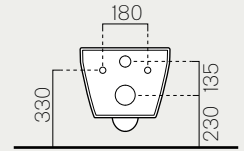
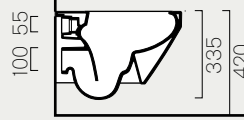
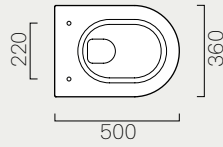

# Vasca

## Bathtub

## Badewanne

**179**

Description	Bathtub
Code	<b>VAT80</b>
Dimensions	179x80 h60
Weight	Kg 64,7
Installation	freestanding
Material	acrylic

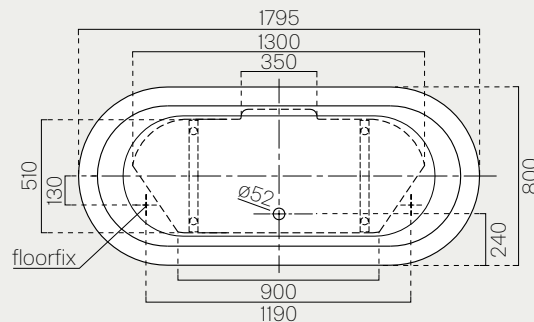
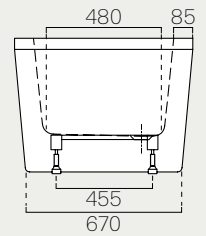
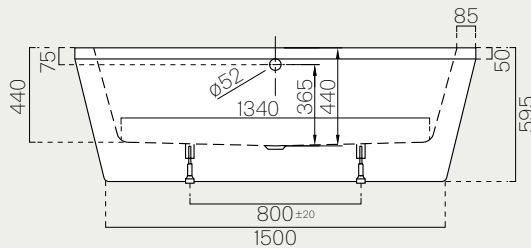

Disegni tecnici  
Technical drawings  
Technische  
Zeichnungen

**Pura**

# Lavabi

## Washbasins

## Waschbecken

Pura

### 120

Description	Washbasin
Code	<b>8824111</b>
Dimensions	120x50 h19
Weight	Kg 29,5
Capacity	Lt 17,5
Overflow	CL 25
Installation	wall-hung, built-in
Taphole	1(5)

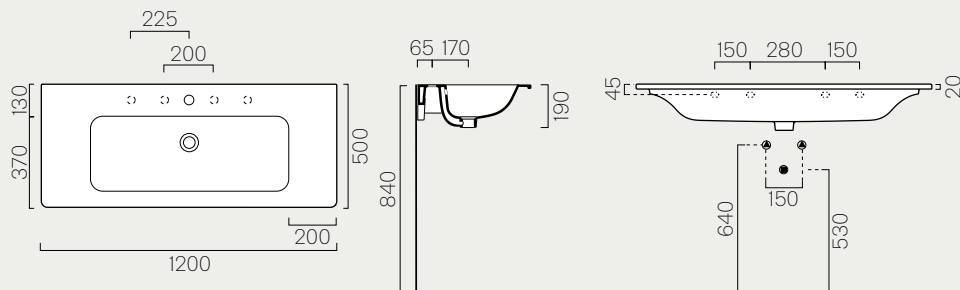

### 100

Description	Washbasin
Code	<b>8823111</b>
Dimensions	100x50 h19
Weight	Kg 23,2
Capacity	Lt 9
Overflow	CL 25
Installation	wall-hung, built-in
Taphole	1(3)

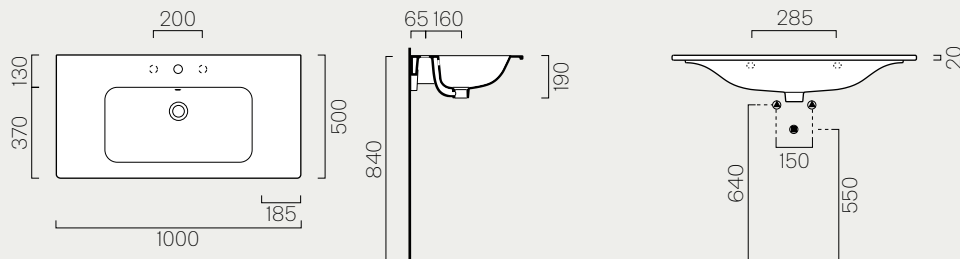

### 80

Description	Washbasin
Code	<b>8822111</b>
Dimensions	80x50 h19
Weight	Kg 17,8
Capacity	Lt 8,5
Overflow	CL 25
Installation	wall-hung, built-in
Taphole	1(3)

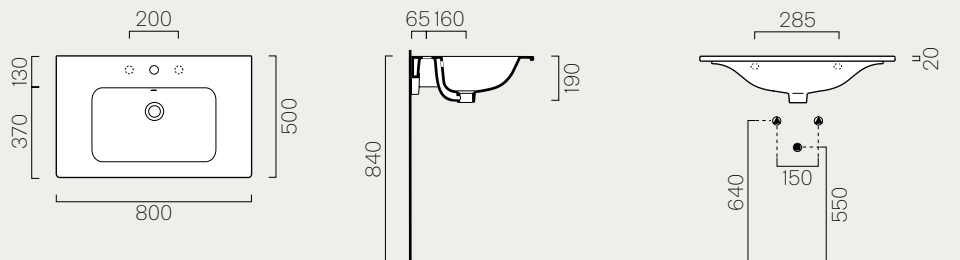

# 80/d

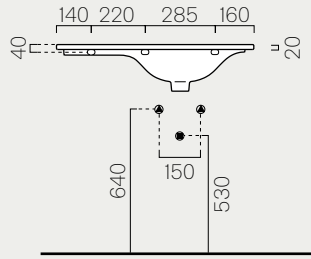
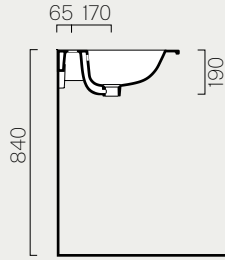
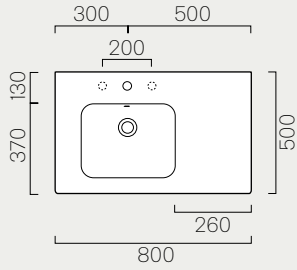

Description	Washbasin
Code	<b>8856111</b>
Dimensions	80x50 h19
Weight	Kg 18
Capacity	Lt 6,5
Overflow	CL 25
Installation	wall-hung, built-in
Taphole	1 (3)

Vista dal retro.  
View from the back.  
Blick von hinten.

# 80/s

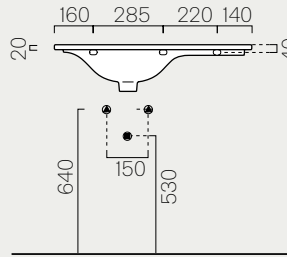
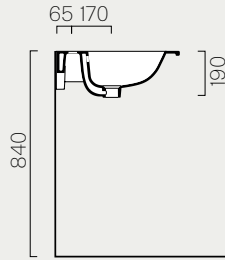
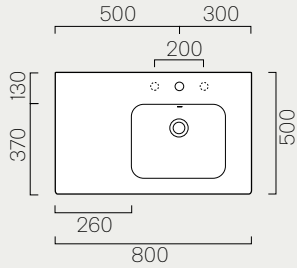

Description	Washbasin
Code	<b>8857111</b>
Dimensions	80x50 h19
Weight	Kg 18
Capacity	Lt 6,5
Overflow	CL 25
Installation	wall-hung, built-in
Taphole	1 (3)

Vista dal retro.  
View from the back.  
Blick von hinten.

# 60

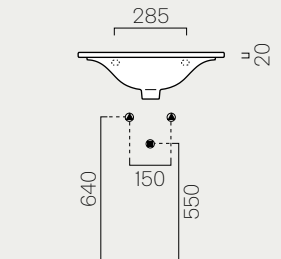
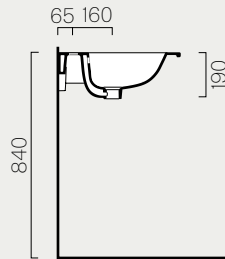
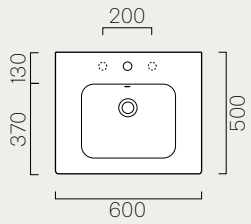

Description	Washbasin
Code	<b>8831111</b>
Dimensions	60x50 h19
Weight	Kg 14,8
Capacity	Lt 6
Overflow	CL 25
Installation	wall-hung, built-in
Taphole	1 (3)

# 102

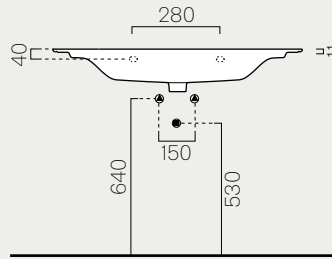
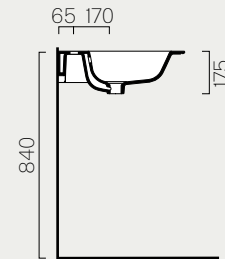
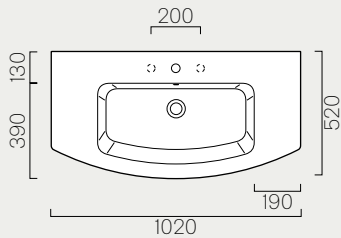

Description	Washbasin
Code	<b>8825111</b>
Dimensions	102x52 h19
Weight	Kg 21,2
Capacity	Lt 9,5
Overflow	CL 25
Installation	wall-hung, built-in
Taphole	1 (3)

## 82

Description	Washbasin
Code	<b>8826111</b>
Dimensions	82x49 h19
Overflow	CL 25
Installation	wall-hung, built-in
Taphole	1 (3)

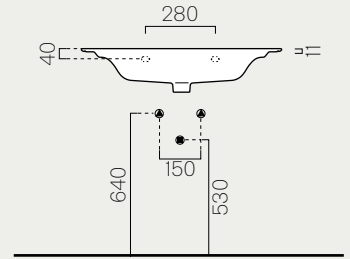
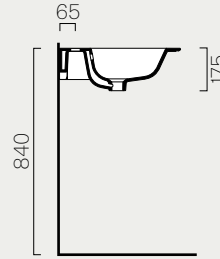
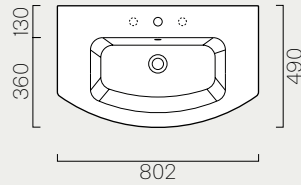

## 60/TI

Description	Washbasin
Code	<b>883711</b>
Dimensions	60x38 h14
Weight	Kg 12,5
Capacity	Lt 9
Overflow	CL 00
Installation	built-in, countertop
Taphole	0

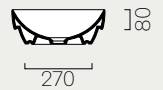
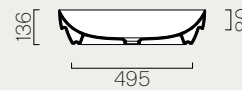
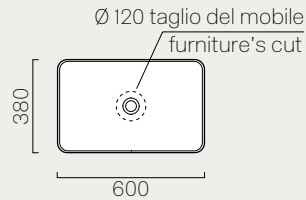

## 50/TI

Description	Washbasin
Code	<b>884711</b>
Dimensions	50x38 h14
Weight	Kg 10,5
Capacity	Lt 7
Overflow	CL 00
Installation	built-in, countertop
Taphole	0

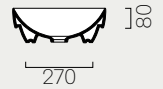
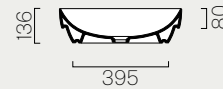
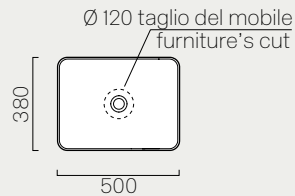

## 39/TI

Description	Washbasin
Code	<b>884611</b>
Dimensions	ø39 h14
Overflow	CL 00
Installation	built-in, countertop
Taphole	0

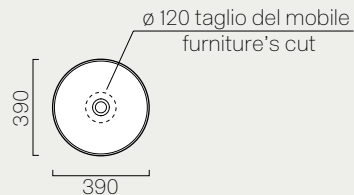

## 38/TI

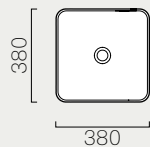

Description	Washbasin
Code	<b>885011</b>
Dimensions	38x38 h14
Weight	Kg 9
Capacity	Lt 5
Overflow	CL 00
Installation	built-in, countertop
Taphole	0

## 60/TS

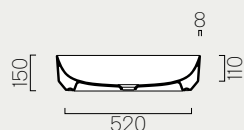
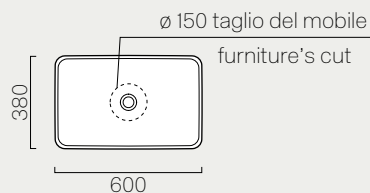

Description	Washbasin
Code	<b>888311</b>
Dimensions	60x38 h15
Weight	Kg 14,8
Capacity	Lt 12
Overflow	CL 00
Installation	countertop
Taphole	0

## 50/TS

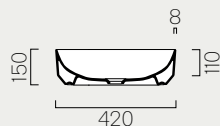
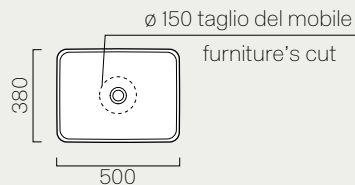

Description	Washbasin
Code	<b>888211</b>
Dimensions	50x38 h15
Weight	Kg 12,7
Capacity	Lt 9
Overflow	CL 00
Installation	countertop
Taphole	0

## 48/TS

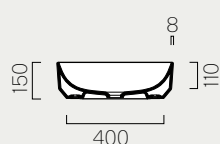

Description	Washbasin
Code	<b>883511</b>
Dimensions	ø48 h15
Weight	Kg 11,5
Capacity	Lt 10
Overflow	CL 00
Installation	countertop
Taphole	0



# 42/TS

Description	Washbasin
Code	<b>882811</b>
Dimensions	ø42 h15
Weight	Kg 9,2
Capacity	Lt 7
Overflow	CL 00
Installation	countertop
Taphole	0

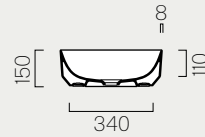
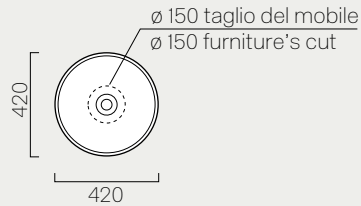

# 55/U

Description	Washbasin
Code	<b>724311</b>
Dimensions	55x38
Weight	Kg 8
Capacity	Lt 9,5
Overflow	CL 25
Installation	under-counter
Taphole	0

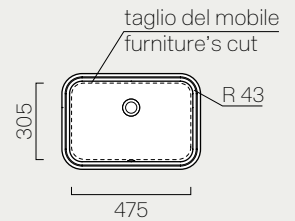
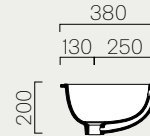
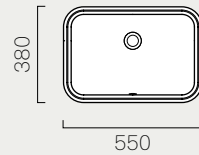

# 50/U

Description	Washbasin
Code	<b>724711</b>
Dimensions	50x35
Weight	Kg 7,6
Capacity	Lt 8
Overflow	CL 25
Installation	under-counter
Taphole	0

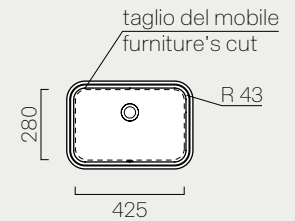
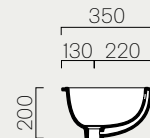
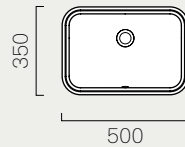

**Wc e Bidet**  
**Wc and Bidet**  
**Wc und Bidet**

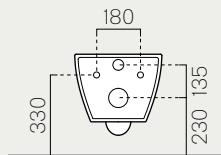
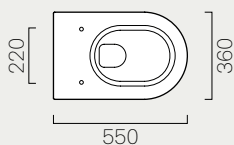
**55**

Description	Wc
Code	<b>881211</b>
Dimensions	55x36
Weight	Kg 23,7
Flush system	standard
Installation	wall-hung

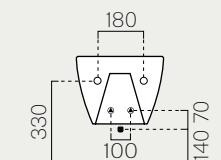
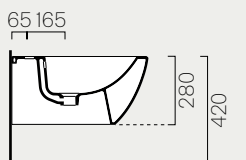
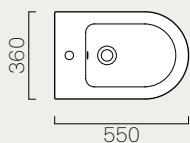
**55**

Description	Bidet
Code	<b>8865111</b>
Dimensions	55x36
Weight	Kg 17
Overflow	CL 25
Installation	wall-hung
Taphole	1

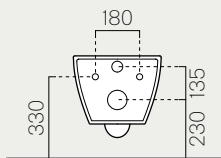
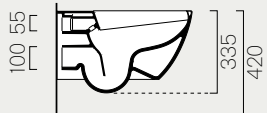
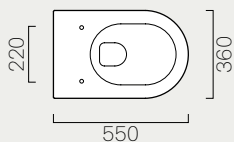
**55/F**

Description	Wc
Code	<b>881511</b>
Dimensions	55x36
Weight	Kg 18,5
Flush system	swirlflush
Installation	wall-hung

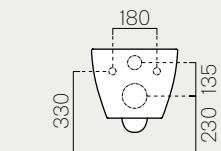
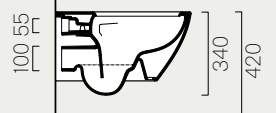
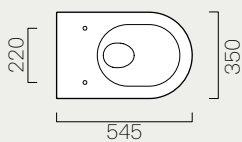
**55/F**

Description	Wc
Code	<b>881111</b>
Dimensions	54,5x35
Weight	Kg 23,3
Flush system	swirlflush
Installation	wall-hung

## 55

Description	Bidet
Code	<b>8861111</b>
Dimensions	54,5x35
Weight	Kg 17,1
Overflow	CL 25
Installation	wall-hung
Taphole	1

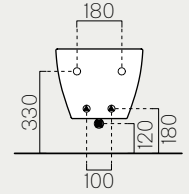
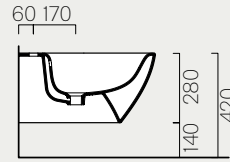
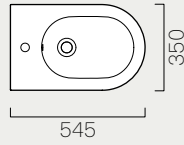

## 50

Description	Wc
Code	<b>881811</b>
Dimensions	50x36
Weight	Kg 18,5
Flush system	standard
Installation	wall-hung

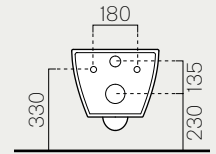
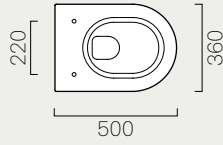

## 50

Description	Bidet
Code	<b>8864111</b>
Dimensions	50x36
Weight	Kg 16,3
Overflow	CL 25
Installation	wall-hung
Taphole	1

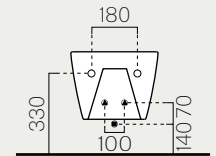
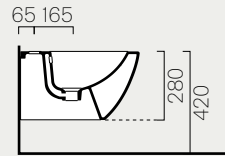
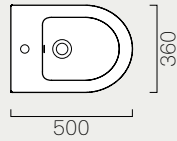

## 50/F

Description	Wc
Code	<b>881611</b>
Dimensions	50x36
Weight	Kg 22,8
Flush system	swirflush
Installation	wall-hung

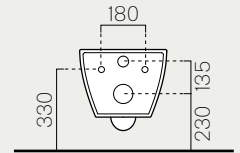
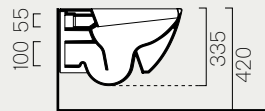
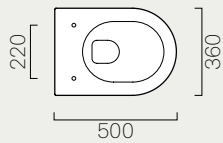

# 55

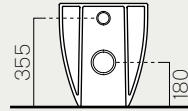
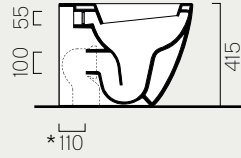
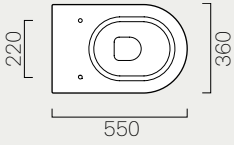

Description	Wc
Code	<b>881411</b>
Dimensions	55x36
Weight	Kg 24,5
Flush system	standard
Installation	floor standing

**Curva tecnica**  
Technical curve



<b>Codice</b> Codes	MCURVA	MCURVAS	MCURVA90
<b>Interasse</b> Distance	* 110	* Da 160 a 185 mm * From 160 to 185 mm	* Da 55 a 75 mm * From 55 to 75 mm

# 55

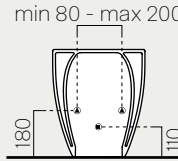
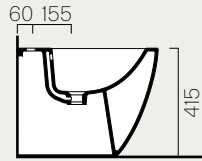
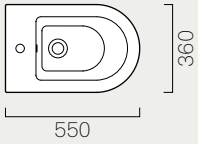

Description	Bidet
Code	<b>8862111</b>
Dimensions	55x36
Weight	Kg 23,1
Overflow	CL 25
Installation	floor standing
Taphole	1

# 55/F

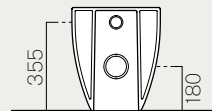
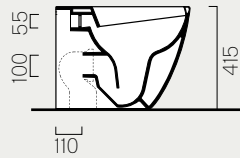
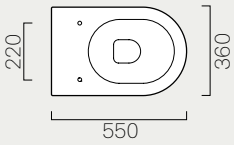

Description	Wc
Code	<b>881911</b>
Dimensions	55x36
Flush system	swirlflush
Installation	floor standing

# 50

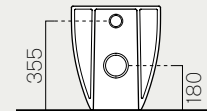
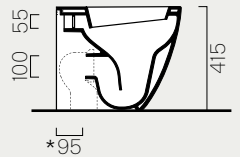
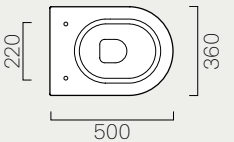

Description	Wc
Code	<b>881911</b>
Dimensions	50x36
Weight	Kg 23,5
Flush system	standard
Installation	floor standing

**Curva tecnica**  
Technical curve



<b>Codice</b> Codes	MCURVA	MCURVAS	MCURVA90
<b>Interasse</b> Distance	* 95	* 165	* 70

# 50

Description	Bidet
Code	<b>8869111</b>
Dimensions	50x36
Weight	Kg 18
Overflow	CL 25
Installation	floor standing
Taphole	1

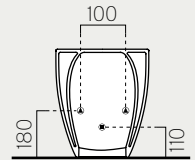
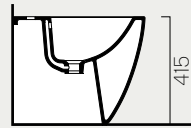
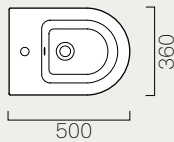

# 68

Description	Wc
Code	<b>881711</b>
Dimensions	68x36
Weight	Kg 33,3
Flush system	standard
Installation	floor standing

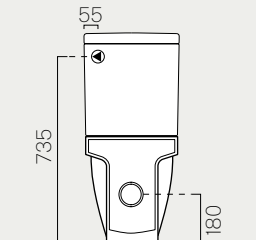
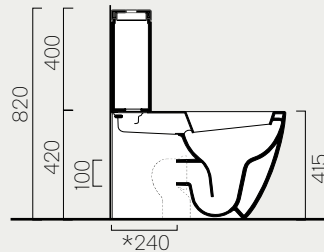
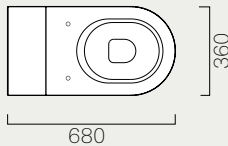

**Curva tecnica**  
Technical curve



**Codice**  
Codes

MCURVAS

MCURVA90

**Interasse**  
Distance

\* Da 230 a 305 mm  
\* From 230 to 305 mm

\* Da 80 a 205 mm  
\* From 80 to 205 mm

Vista dal retro.  
View from the back.  
Blick von hinten.

# Cassetta

Description	Cistern
Code	<b>868111</b>
Dimensions	17x31 43h
Weight	Kg 13,5

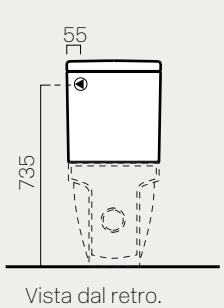
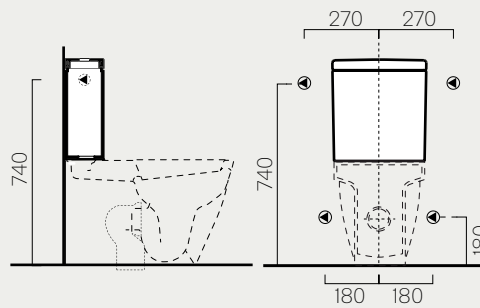
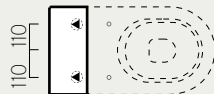

Vista dal retro.  
View from the back.  
Blick von hinten.

# Scocca

Description	Ceramic Cover
Code	<b>869111</b>
Dimensions	13x35,5 46h
Weight	Kg 9,6

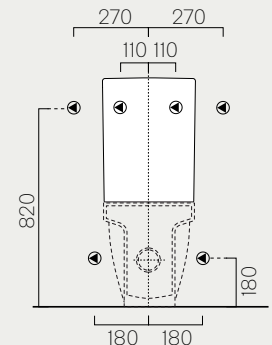
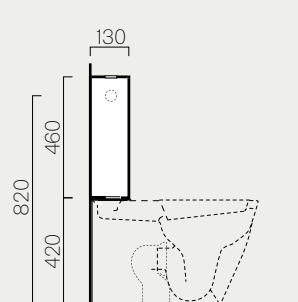

Vista dal retro.  
View from the back.  
Blick von hinten.

# Orinatoio

## Urinal

## Urinal

### 39

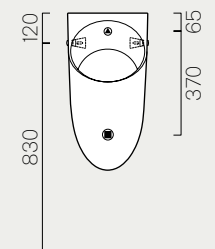
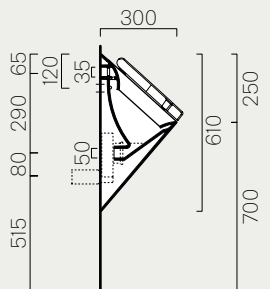
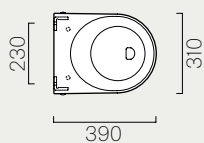

Description	Urinal
Code	<b>769711</b>
Dimensions	31x39 h60
Weight	Kg 12,4

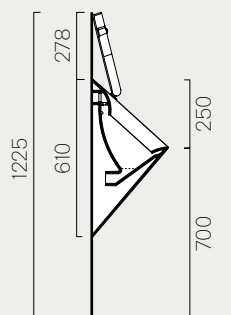
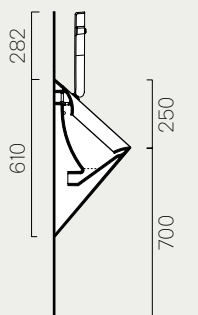

### 36

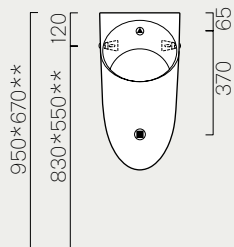
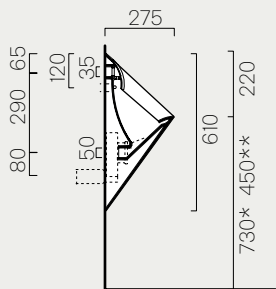
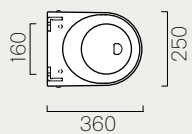

Description	Urinal
Code	<b>889711</b>
Dimensions	25x36 h60
Weight	Kg 9,8

\* uomo/man  
\*\* bambino/kid

# Vasca

## Bathtub

## Badewanne

Pura

# 190

Description	Bathtub
Code	<b>VAPR90</b>
Dimensions	190x90
Weight	Kg 53
Installation	freestanding
Material	acrylic

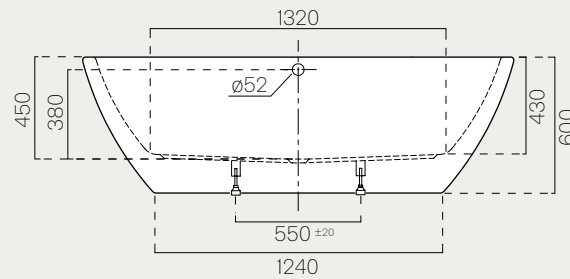
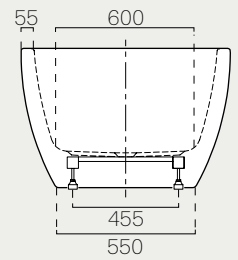
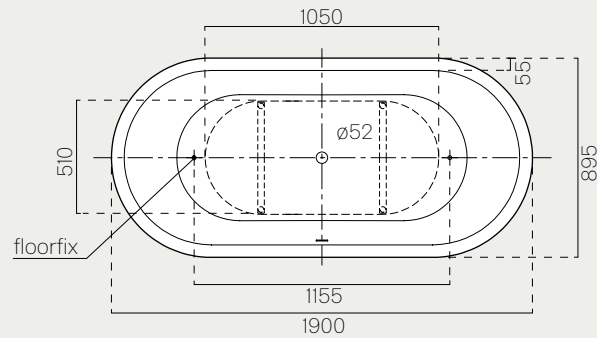

Disegni tecnici  
Technical drawings  
Technische  
Zeichnungen

**Modo**



# Lavabi

## Washbasins

## Waschbecken

Modo

### 120

Description	Washbasin
Code	<b>7724111</b>
Dimensions	120x50 h18
Weight	Kg 29
Capacity	Lt 11
Overflow	CL 25
Installation	wall-hung, built-in
Taphole	1(3)

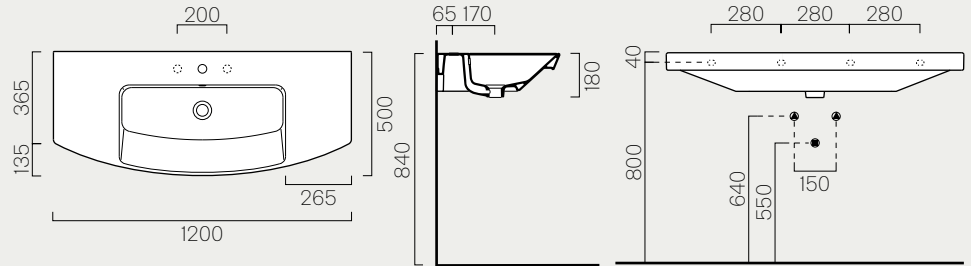

### 100

Description	Washbasin
Code	<b>7723111</b>
Dimensions	100x50 h18
Weight	Kg 24,6
Capacity	Lt 9,5
Overflow	CL 25
Installation	wall-hung, built-in
Taphole	1(3)

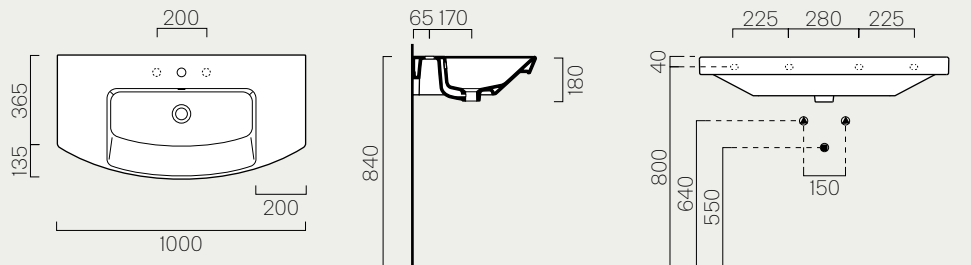

### 80

Description	Washbasin
Code	<b>7722111</b>
Dimensions	80x50 h18
Weight	Kg 21,1
Capacity	Lt 9
Overflow	CL 25
Installation	wall-hung, built-in
Taphole	1(3)

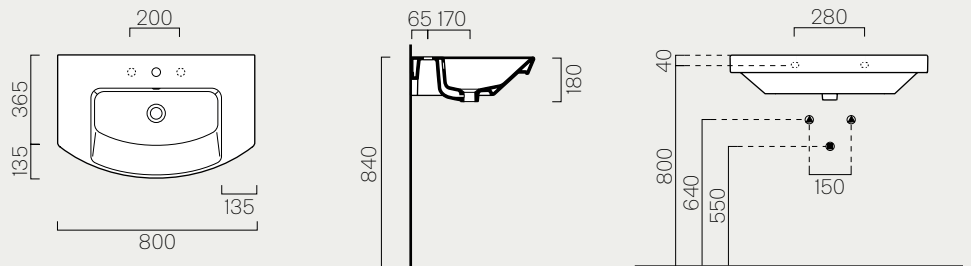

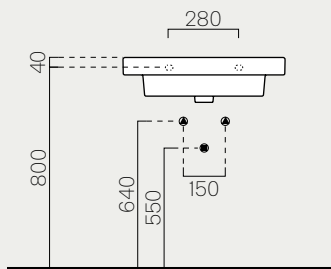
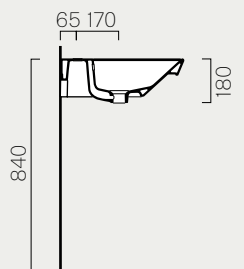
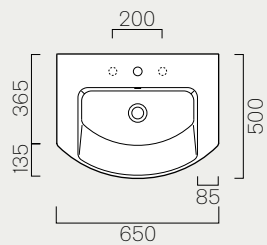
**65**

Description	Washbasin
Code	<b>7732111</b>
Dimensions	65x50 h18
Weight	Kg 20,1
Capacity	Lt 8,5
Overflow	CL 25
Installation	wall-hung, built-in
Taphole	1 (3)

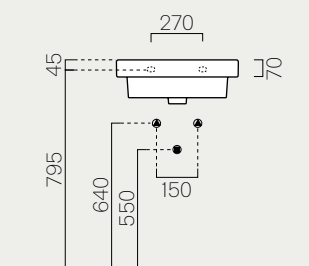
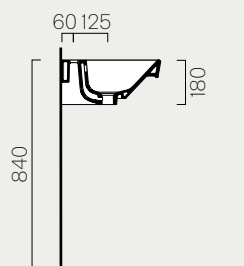
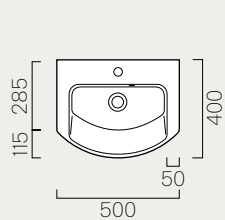
**50**

Description	Washbasin
Code	<b>7785111</b>
Dimensions	50x40 h18
Weight	Kg 11,4
Capacity	Lt 5
Overflow	CL 25
Installation	wall-hung, built-in
Taphole	1

# Wc e Bidet

## Wc and Bidet

### Wc und Bidet

## 55

Description	Wc
Code	<b>771211</b>
Dimensions	55x38
Weight	Kg 22
Flush system	standard
Installation	wall-hung

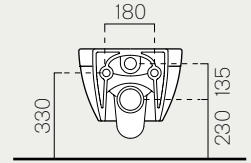
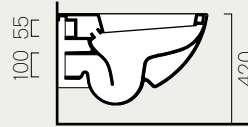
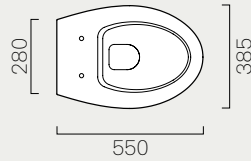

## 55

Description	Bidet
Code	<b>771511</b>
Dimensions	55x38
Weight	Kg 15,5
Overflow	CL 25
Installation	wall-hung
Taphole	1

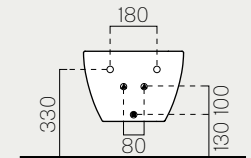
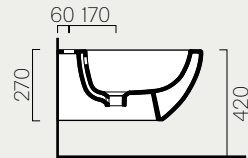
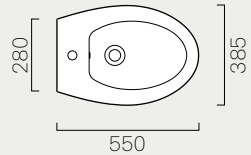

## 51

Description	Wc
Code	<b>771011</b>
Dimensions	51x38
Weight	Kg 21,1
Flush system	standard
Installation	wall-hung

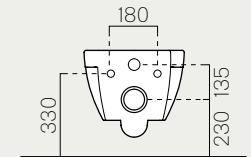
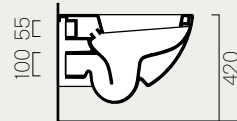
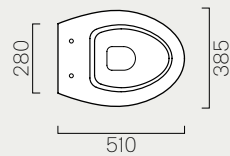

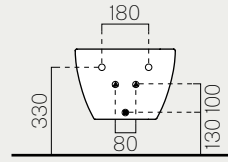
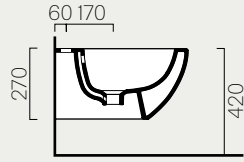
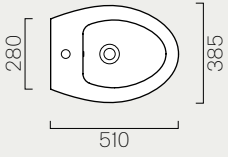

Description	Bidet
Code	<b>7760111</b>
Dimensions	51x38
Weight	Kg 15,9
Overflow	CL 25
Installation	wall-hung
Taphole	1

# Vasca

## Bathtub

## Badewanne

Modo

# 190

Description	Bathtub
Code	<b>VAM95</b>
Dimensions	190x95
Weight	Kg 80
Installation	freestanding
Material	acrylic

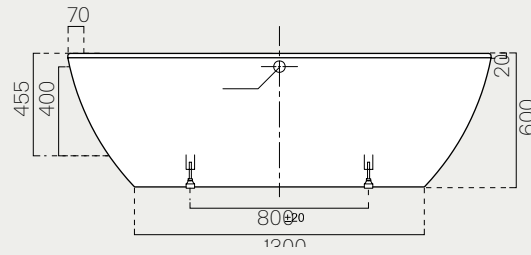
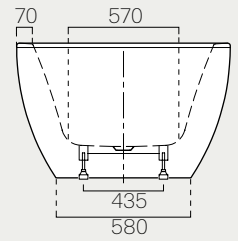
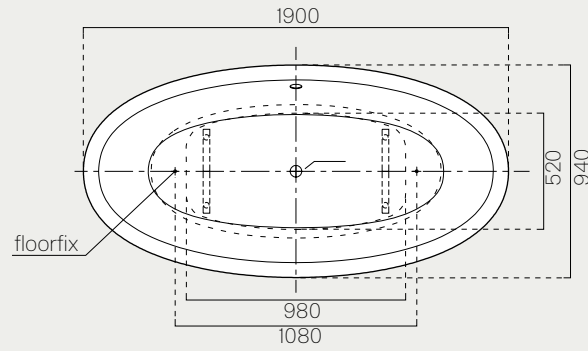

Disegni tecnici  
Technical drawings  
Technische  
Zeichnungen

**Classic**

# Lavabi

## Washbasins

## Waschbecken

Classic

### 125

Description	Washbasin
Code	<b>8725111</b>
Dimensions	125x54
Weight	Kg 42,1
Capacity	Lt 10
Overflow	CL 25
Installation	wall-hung, ceramic legs
Taphole	1 (3)

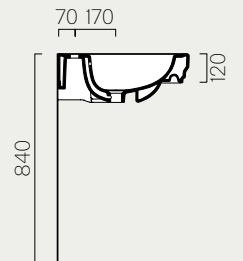
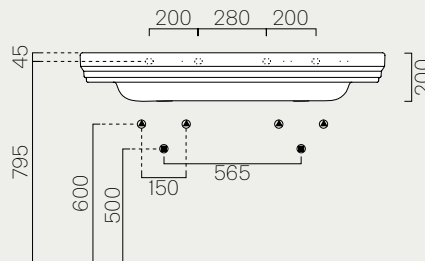
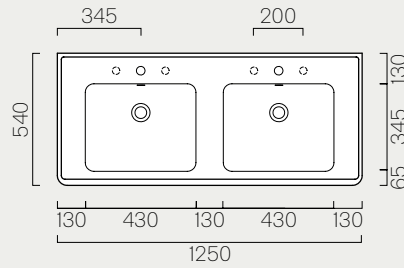

### 105

Description	Washbasin
Code	<b>8723111</b>
Dimensions	105x54
Weight	Kg 28
Capacity	Lt 12
Overflow	CL 25
Installation	wall-hung, ceramic legs, pedestal
Taphole	1 (3)

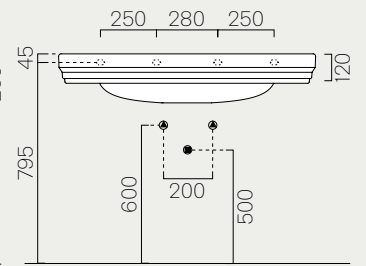
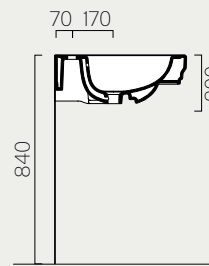
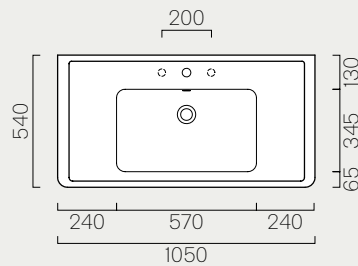

# 90

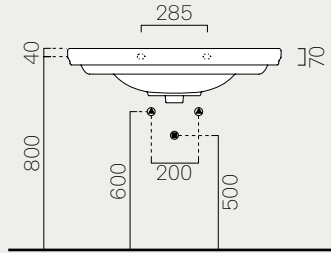
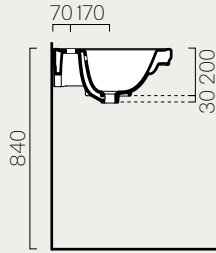
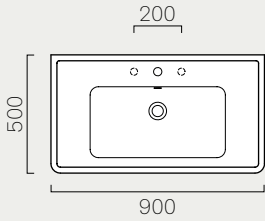

Description	Washbasin
Code	<b>8788111</b>
Dimensions	90x50
Weight	Kg 25,3
Capacity	Lt 10,5
Overflow	CL 25
Installation	wall-hung, pedestal
Taphole	1 (3)

# 75

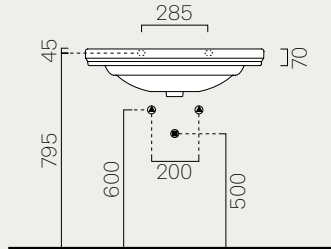
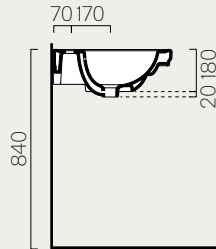
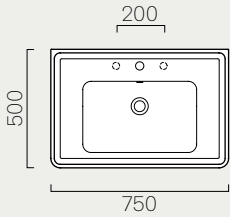

Description	Washbasin
Code	<b>8787111</b>
Dimensions	75x50
Weight	Kg 19,3
Capacity	Lt 6
Overflow	CL 25
Installation	wall-hung, pedestal
Taphole	1 (3)

# 60

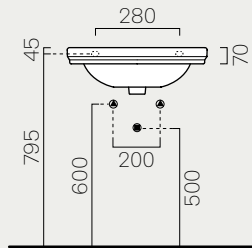
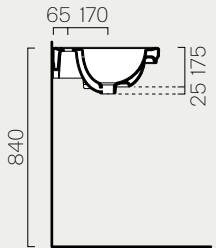
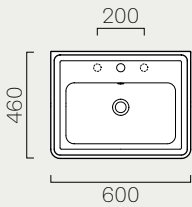

Description	Washbasin
Code	<b>8781111</b>
Dimensions	60x46
Weight	Kg 15,5
Capacity	Lt 5
Overflow	CL 25
Installation	wall-hung, pedestal
Taphole	1 (3)

# Colonna

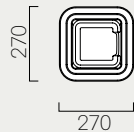
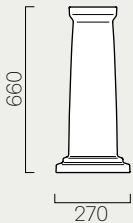

Description	Pedestal
Code	<b>877011</b>
Dimensions	66x27



# 60/T

Description	Washbasin
Code	<b>874911</b>
Dimensions	60x40
Weight	Kg 14,4
Capacity	Lt 8
Overflow	CL 25
Installation	countertop, built-in
Taphole	0

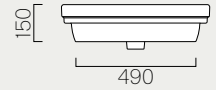
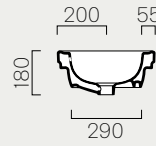
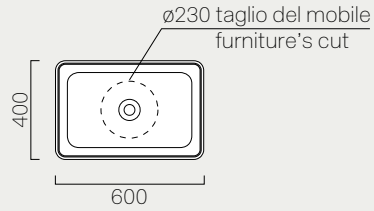

# 55/U

Description	Washbasin
Code	<b>724311</b>
Dimensions	55x38
Weight	Kg 8
Capacity	Lt 9,5
Overflow	CL 25
Installation	under-counter
Taphole	0

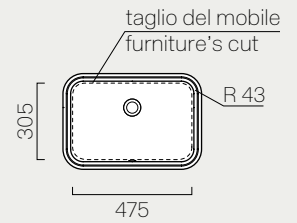
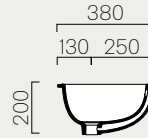
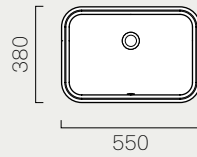

# 50/U

Description	Washbasin
Code	<b>724711</b>
Dimensions	50x35
Weight	Kg 7,6
Capacity	Lt 8
Overflow	CL 25
Installation	under-counter
Taphole	0

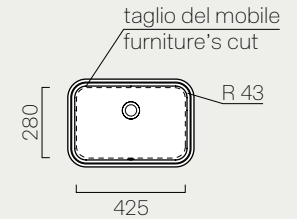
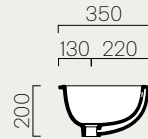
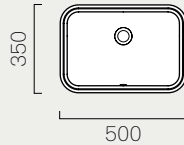

# Wc e Bidet

## Wc and Bidet

## Wc und Bidet

**55**

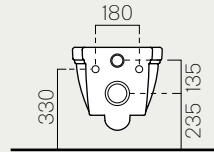
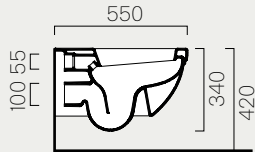
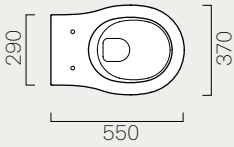

Description	Wc
Code	<b>871211</b>
Dimensions	55x37
Weight	Kg 20,5
Flush system	standard
Installation	wall-hung

**55**

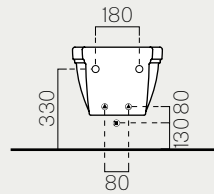
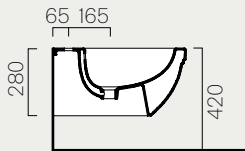
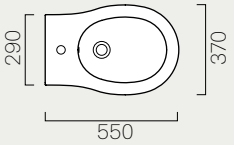

Description	Bidet
Code	<b>8765111</b>
Dimensions	55x37
Weight	Kg 17
Overflow	CL 25
Installation	wall-hung
Taphole	1

**54**

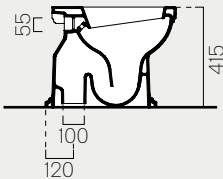
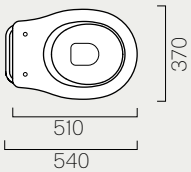

Description	Wc
Code	<b>871011</b>
Dimensions	54x37
Weight	Kg 22,5
Flush system	standard
Installation	floor standing

## 54

Description	Wc
Code	<b>871111</b>
Dimensions	54x37
Weight	Kg 22,5
Flush system	standard
Installation	floor standing

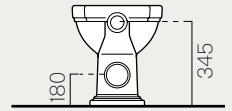
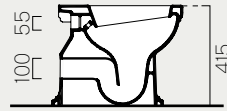
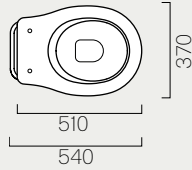

## 54

Description	Bidet
Code	<b>8762111</b>
Dimensions	54x37
Weight	Kg 18,2
Overflow	CL 25
Installation	floor standing
Taphole	1 (3)

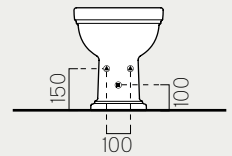
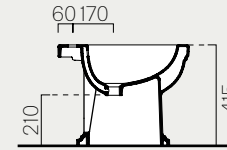
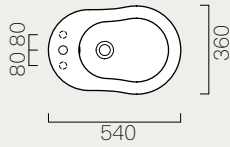

## 70

Description	Wc
Code	<b>871711</b>
Dimensions	70x37
Weight	Kg 25,2
Flush system	standard
Installation	floor standing

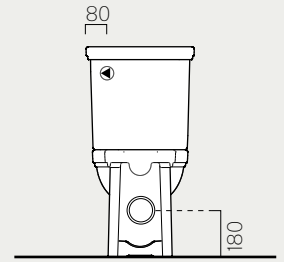
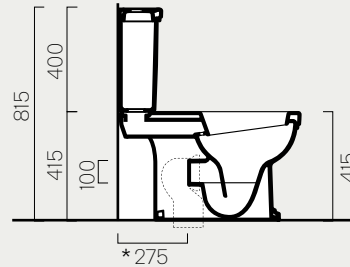
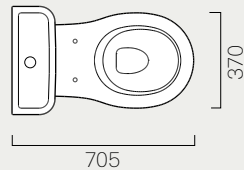

**Curva tecnica**  
Technical curve

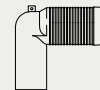

**Codice**  
Codes

MCURVA

MCURVAS

MCURVA90

**Interasse**  
Distance

\* 275

\* Da 250 a 320 mm  
\* From 250 to 320 mm

\* Da 80 a 230 mm  
\* From 80 to 230 mm

# Cassetta

Description	Cistern
Code	<b>878111</b>
Dimensions	17x42 h40
Weight	Kg 13,6

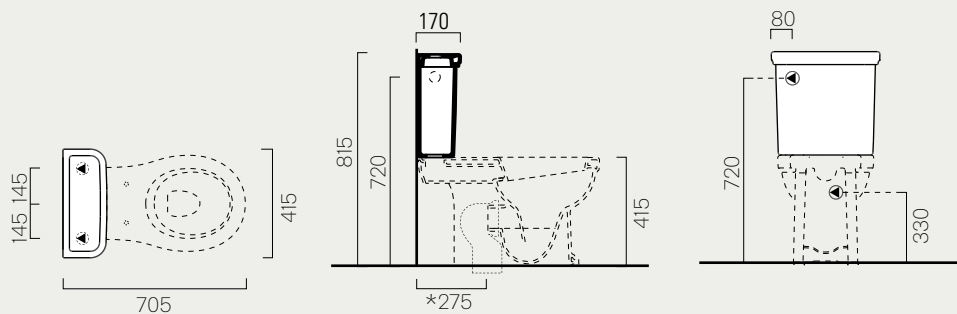

# Cassetta

Description	Cistern
Code	<b>879011</b>
Dimensions	46x22 h41
Weight	Kg 16,5

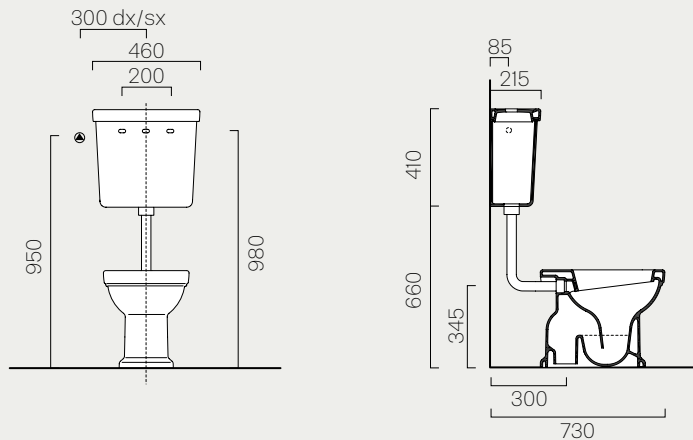

# Cassetta

Description	Cistern
Code	<b>878011</b>
Dimensions	46x22 h41
Weight	Kg 16,5

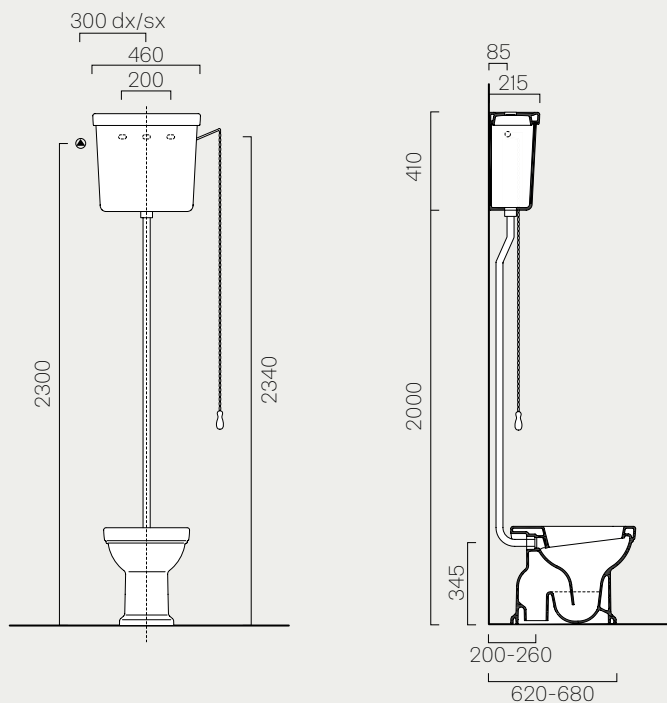

# Vasca

## Bathtub

### Badewanne

Classic

# 175

Description	Bathtub
Code	<b>VAL1</b>
Dimensions	175x82 h84
Weight	Kg 65,3
Installation	freestanding
Material	acrylic

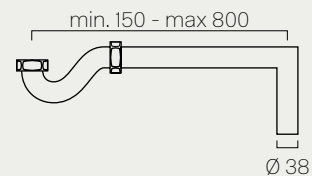
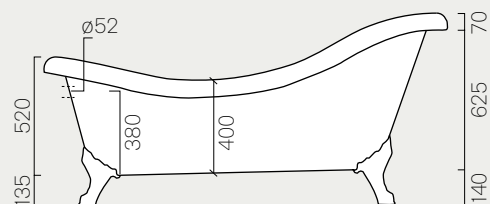

Description	Bathtub
Code	<b>VAL2</b>
Dimensions	175x82 h85
Weight	Kg 66,3
Installation	freestanding
Material	acrylic

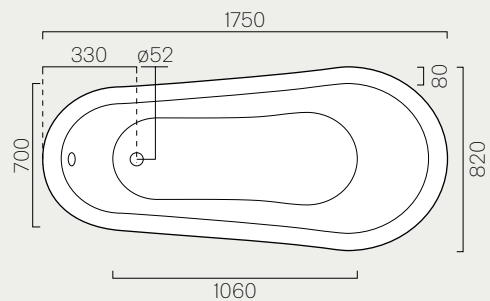

Disegni tecnici  
Technical drawings  
Technische  
Zeichnungen

**Community**

# Lavabi

## Washbasins

### Waschbecken

70

Description	Washbasin
Code	<b>7631011</b>
Dimensions	70X60 h16
Weight	Kg 21,8
Capacity	Lt 12
Overflow	CL 00
Installation	wall-hung,
Taphole	1(3)

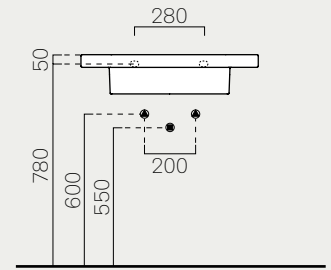
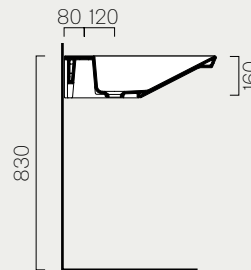
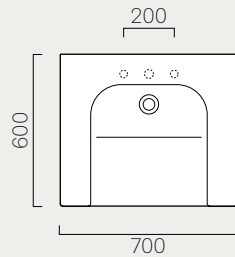

# Wc e Bidet

## Wc and Bidet

### Wc und Bidet

70

Description	Wc
Code	<b>761811</b>
Dimensions	70x37
Weight	Kg 26,4
Flush system	standard
Installation	wall-hung

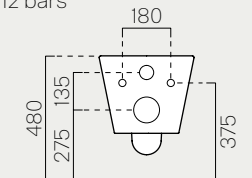
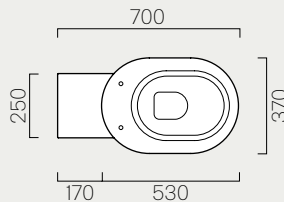

Fissaggio solo su barre M12  
To be fixed exclusively on M12 bars

# Orinatoio

## Urinal

## Urinal

**39**

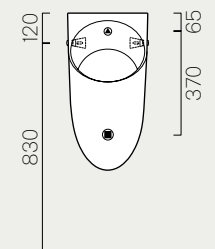
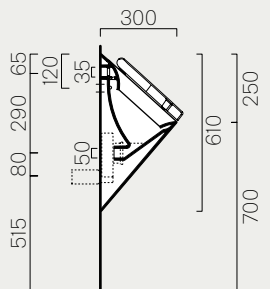
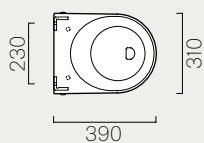

Description	Urinal
Code	<b>769711</b>
Dimensions	31x39 h60
Weight	Kg 12,4
Flush system	standard
Installation	wall-hung

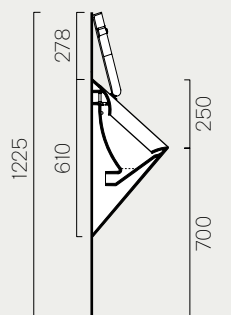
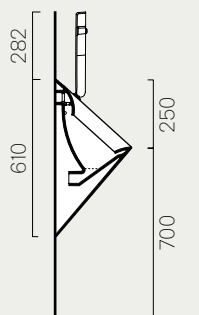



# Piatti doccia H6

## Shower trays H6

### H6 Duschwannen

## 140

Description	Shower trays
Code	<b>358711</b>
Dimensions	140x80 h6
Weight	Kg 49,5
Installation	freestanding, flush-fitting
Material	ceramic

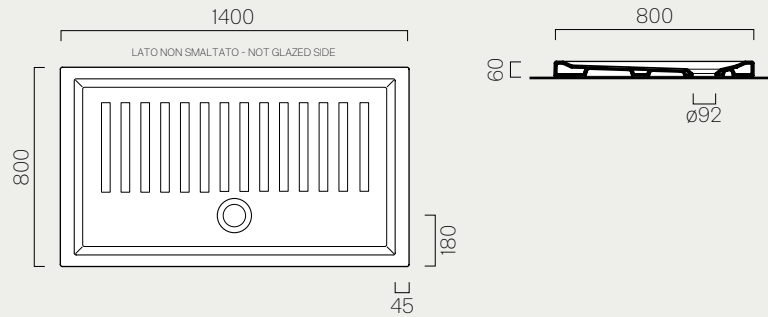

## 120

Description	Shower trays
Code	<b>359811</b>
Dimensions	120x80 h6
Weight	Kg 45,8
Installation	freestanding, flush-fitting
Material	ceramic

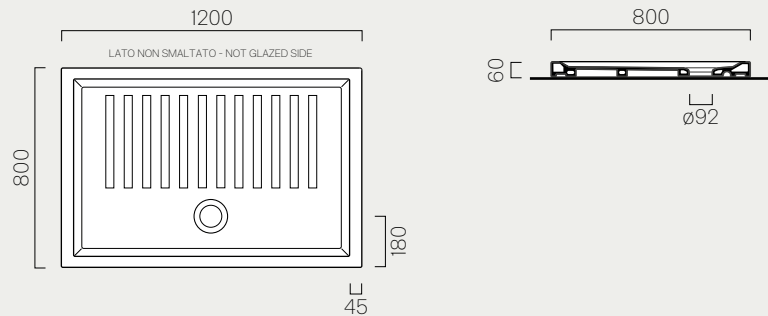

## 120

Description	Shower trays
Code	<b>359911</b>
Dimensions	120x70 h6
Weight	Kg 40,3
Installation	freestanding, flush-fitting
Material	ceramic

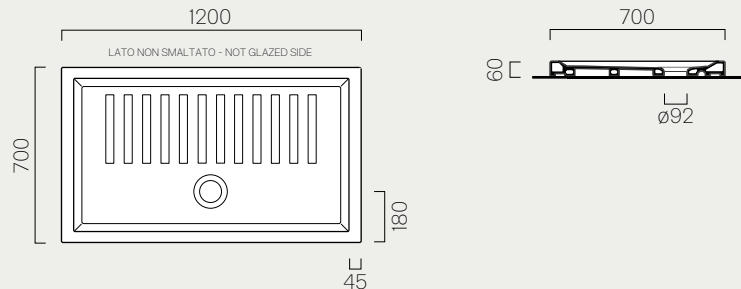

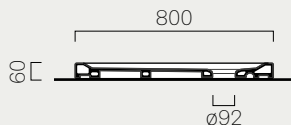
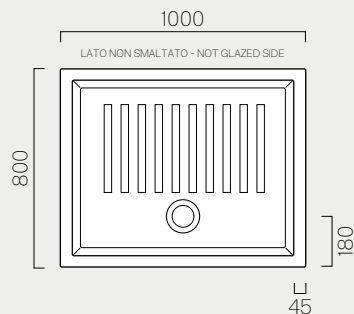
**100**

Description	Shower trays
Code	<b>358611</b>
Dimensions	100x80 h6
Weight	Kg 38,5
Installation	freestanding, flush-fitting
Material	ceramic

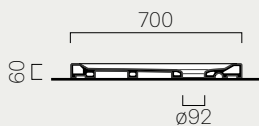
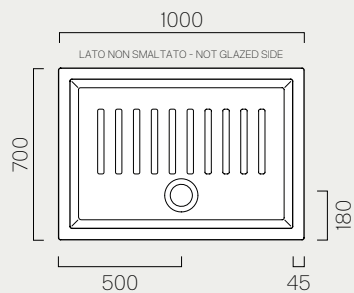
**100**

Description	Shower trays
Code	<b>358911</b>
Dimensions	100x70 h6
Weight	Kg 33,7
Installation	freestanding, flush-fitting
Material	ceramic

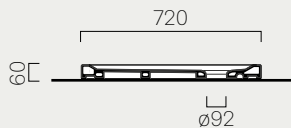
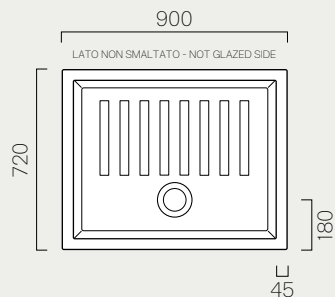
**90**

Description	Shower trays
Code	<b>359711</b>
Dimensions	90x72 h6
Weight	Kg 31,5
Installation	freestanding, flush-fitting
Material	ceramic

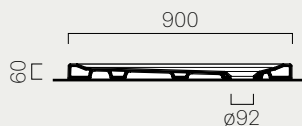
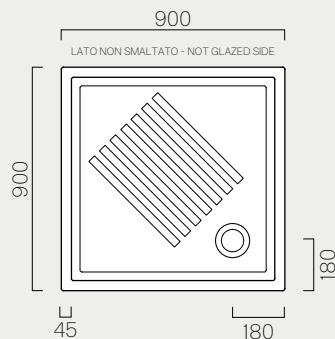
**90/a**

Description	Shower trays
Code	<b>339711</b>
Dimensions	90x90 h6
Weight	Kg 35,9
Installation	freestanding, flush-fitting
Material	ceramic

## 80/α

Description	Shower trays
Code	<b>338611</b>
Dimensions	80x80 h6
Weight	Kg 31,1
Installation	freestanding, flush-fitting
Material	ceramic

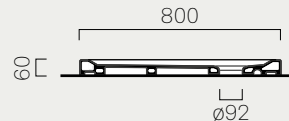
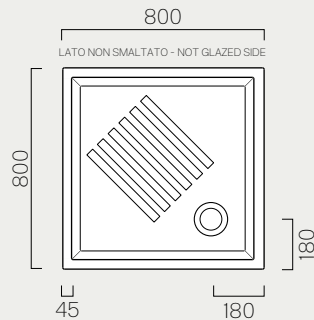

## 90

Description	Shower trays
Code	<b>349711</b>
Dimensions	90x90 h6
Weight	Kg 31,3
Installation	freestanding, flush-fitting
Material	ceramic

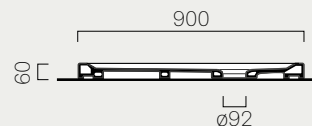
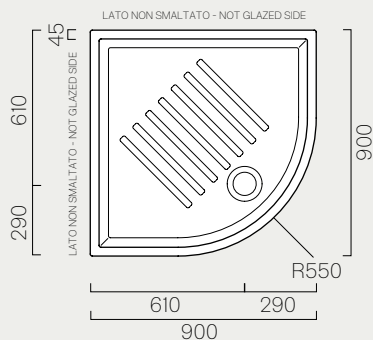

## 80

Description	Shower trays
Code	<b>348611</b>
Dimensions	80x80h6
Weight	Kg 26
Installation	freestanding, flush-fitting
Material	ceramic

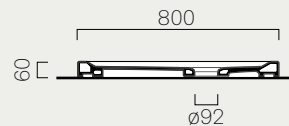
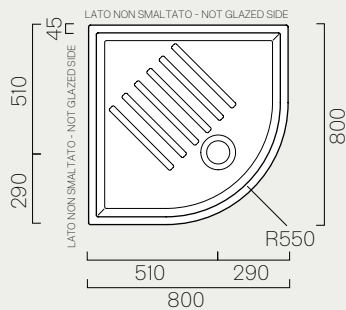



## Italian Made

I prodotti presenti in questo volume sono progettati e realizzati in Italia secondo i più alti standard qualitativi, nella tutela dell'ambiente, dei diritti e della salute dei lavoratori.

The products in this catalog are designed and produced in Italy according to the highest quality standards, the environmental protection and ofcourse according to the rights and health of employees.

Die Produkte in diesem Katalog wurden in Italien unter Achtung der höchsten Qualitätsanforderungen, des Umweltschutzes und selbstverständlich der Rechte und der Gesundheit der Mitarbeiter entworfen und hergestellt.

Art Direction/Layout  
Studio CCRZ

Photography  
Studio Ciapetti

Styling  
Monti Studio

Coordination  
GSI Lab

Printed by  
Intese Grafiche

Thanks to  
cc tapis  
rugstar  
bloc studio  
living divani  
luceplan  
catellani & smith  
desalto  
il giardino di legno  
fioroni  
moroso  
zanotta  
scarazzini  
cristina rubinetterie

Le immagini e i dati contenuti nel presente catalogo sono da ritenersi indicativi e possono subire variazioni anche senza alcun preavviso.

Images and data contained in this catalogue are to be considered indicative and may be changed also without any notice.

Die in diesem Katalog enthaltenen Bilder und Daten gelten als hinweisend und können jederzeit geändert werden.

stampato 4/17  
printed 4/17  
gedruckt 4/17

## GSI

S.p.a. Strada Provinciale 150, km 3,125  
01035 Gallese (VT), Italia  
T +39 07614911  
F +39 0761496111  
[www.gsiceramica.it](http://www.gsiceramica.it)

